

datavideo

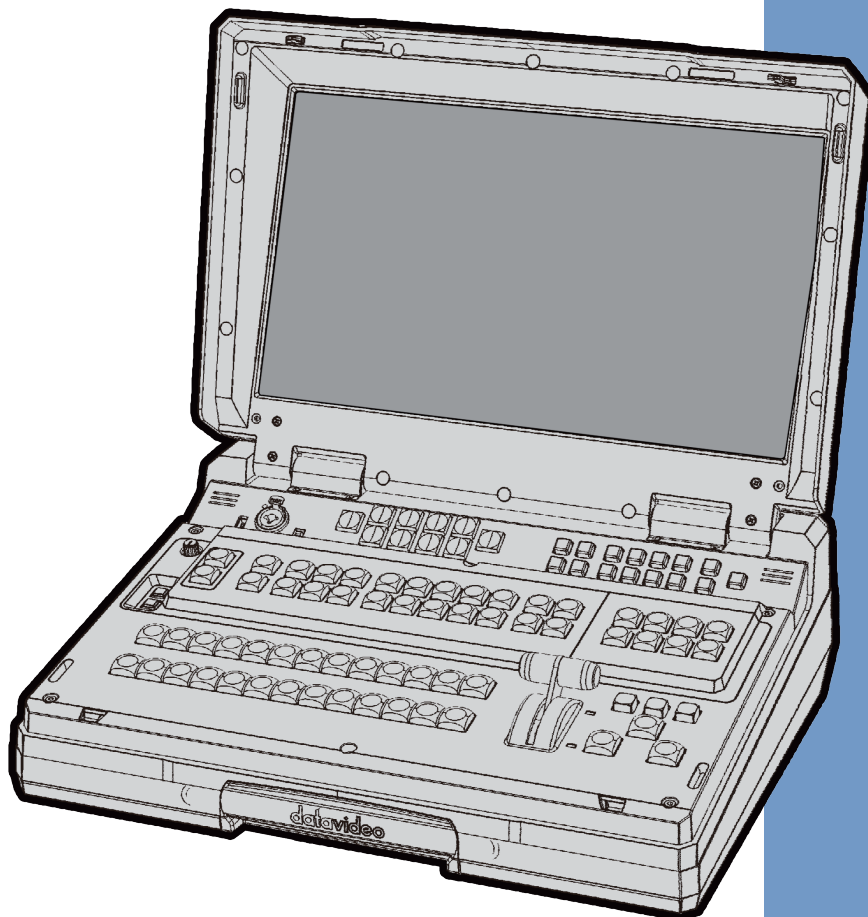

**HD/SD 12-CHANNEL
PORTABLE VIDEO STUDIO**

HS-2850
(8 / 12 CHANNEL)

Instruction manual

www.datavideo.com

Table of Contents

WARNINGS AND PRECAUTIONS	5
WARRANTY.....	6
STANDARD WARRANTY	6
THREE YEAR WARRANTY	6
DISPOSAL.....	7
CHAPTER 1 INTRODUCTION	8
1.1 FEATURES	8
1.2 SYSTEM DIAGRAM.....	10
CHAPTER 2 CONNECTIONS AND CONTROLS.....	11
2.1 MAIN UNIT – REAR PANEL OVERVIEW	11
2.1.1 Rear Panel Connections	11
2.2 CONTROL PANEL OVERVIEW	15
2.2.1 Video Switching	15
Program and Preset rows	15
Background	16
2.2.2 Video Transitions	16
Transition Selection	16
Triggering the Transition.....	17
2.2.3 Logo and Clock	18
2.2.4 Picture-in-Picture and Downstream Key.....	19
2.2.5 Frame Store and Audio Control.....	20
2.2.6 Crosspoint	20
2.2.7 OSD MENU Options	21
2.2.8 PC Control – SE Remote Control Software	26
SET Function	26
REC & PLAY Functions.....	27
Software-based Macro Functions	27
TIME Function	27
2.3 INTERCOM & MONITOR CONTROL PANEL	28
2.3.1 Intercom Function.....	28
2.3.2 Monitor Function.....	29
2.3.3 Monitor Menu Options	30
MAIN ADJUST	31
COLOR	31
Information	31
Special Function	32
Factory Reset.....	32
CHAPTER 3 SWITCHER CONFIGURATION UTILITY (SECONFIG SOFTWARE)	33

3.1	NETWORK SETUP	33
3.2	CONNECTING THE SECONFIG SOFTWARE TO THE SWITCHER	36
3.2.1	<i>Change the Switcher IP Address</i>	37
3.3	SWITCHER TAB	38
3.3.1	<i>Profiles</i>	39
3.4	SETTINGS TAB.....	39
3.4.1	<i>Inputs tab</i>	39
3.4.2	<i>Audio Tab</i>	40
3.4.3	<i>Video XPT Tab</i>	43
3.4.4	<i>Common Setup</i>	45
3.4.5	<i>Outputs Tab</i>	48
3.5	IMAGES UPLOAD TAB.....	49
3.5.1	<i>Still Pictures</i>	49
3.5.2	<i>Logos</i>	50
3.5.3	<i>Dynamic Logo</i>	51
3.6	MULTI SCREEN WINDOW SIGNS (LABELS) TAB	52
3.7	MULTIVIEW LAYOUT TAB.....	53
3.8	MULTIVIEW UPLOAD TABS (A / B / C).....	54
CHAPTER 4 SWITCHER VIDEO.....		55
4.1	HDMI MULTI-VIEW.....	55
4.2	VIDEO LAYERS	56
CHAPTER 5 AUDIO FUNCTION.....		58
5.1	OVERVIEW	58
5.2	AUDIO MENU OPTIONS – DE-EMBEDDING SDI OR HDMI AUDIO.....	58
5.3	AUDIO MENU OPTIONS – MONITORING THE AUDIO LEVELS.....	60
5.4	AUDIO MENU OPTIONS – CHANGING THE AUDIO INPUT LEVEL	61
5.5	WORKING WITH A FIXED OR SINGLE AUDIO SOURCE.....	61
5.6	SWITCHING BETWEEN DIFFERENT EMBEDDED AUDIO SOURCES	61
5.7	AUDIO DELAY	62
CHAPTER 6 APPLICATIONS		63
6.1	PICTURE-IN-PICTURE FUNCTION	63
6.2	DOWN STREAM KEYER	64
6.3	HOW TO DOWNLOAD THE CG-200 CG SOFTWARE	64
6.4	HS-2850 AND CG SETUP	64
CHAPTER 7 APPENDICES		68
APPENDIX 1	UPGRADING HS-2850 TO 12 CHANNELS	68
APPENDIX 2	TALLY OUTPUTS.....	70
APPENDIX 3	GPI / GPO CONNECTIONS.....	71
APPENDIX 4	RS-422 PHYSICAL CONNECTION.....	72
APPENDIX 5	FIRMWARE UPDATE.....	73

<i>Keyboard Firmware Update</i>	73
<i>T-Bar Re-Calibration</i>	76
<i>Monitor Firmware Update</i>	77
APPENDIX 6 FREQUENTLY-ASKED QUESTIONS	78
APPENDIX 7 DIMENSIONS & WEIGHT.....	79
APPENDIX 8 SPECIFICATIONS.....	80
SERVICE AND SUPPORT	82

Disclaimer of Product & Services

The information offered in this instruction manual is intended as a guide only. At all times, Datavideo Technologies will try to give correct, complete and suitable information. However, Datavideo Technologies cannot exclude that some information in this manual, from time to time, may not be correct or may be incomplete. This manual may contain typing errors, omissions or incorrect information. Datavideo Technologies always recommend that you double check the information in this document for accuracy before making any purchase decision or using the product. Datavideo Technologies is not responsible for any omissions or errors, or for any subsequent loss or damage caused by using the information contained within this manual. Further advice on the content of this manual or on the product can be obtained by contacting your local Datavideo Office or dealer.

FCC Compliance Statement

This device complies with part 15 of the FCC rules. Operation is subject to the following two conditions:

- (1) This device may not cause harmful interference, and
- (2) This device must accept any interference received, including interference that may cause undesired operation.

Warnings and Precautions



1. Read all of these warnings and save them for later reference.
2. Follow all warnings and instructions marked on this unit.
3. Unplug this unit from the wall outlet before cleaning. Do not use liquid or aerosol cleaners. Use a damp cloth for cleaning.
4. Do not use this unit in or near water.
5. Do not place this unit on an unstable cart, stand, or table. The unit may fall, causing serious damage.
6. Slots and openings on the cabinet top, back, and bottom are provided for ventilation. To ensure safe and reliable operation of this unit, and to protect it from overheating, do not block or cover these openings. Do not place this unit on a bed, sofa, rug, or similar surface, as the ventilation openings on the bottom of the cabinet will be blocked. This unit should never be placed near or over a heat register or radiator. This unit should not be placed in a built-in installation unless proper ventilation is provided.
7. This product should only be operated from the type of power source indicated on the marking label of the AC adapter. If you are not sure of the type of power available, consult your Datavideo dealer or your local power company.
8. Do not allow anything to rest on the power cord. Do not locate this unit where the power cord will be walked on, rolled over, or otherwise stressed.
9. If an extension cord must be used with this unit, make sure that the total of the ampere ratings on the products plugged into the extension cord do not exceed the extension cord rating.
10. Make sure that the total amperes of all the units that are plugged into a single wall outlet do not exceed 15 amperes.
11. Never push objects of any kind into this unit through the cabinet ventilation slots, as they may touch dangerous voltage points or short out parts that could result in risk of fire or electric shock. Never spill liquid of any kind onto or into this unit.
12. Except as specifically explained elsewhere in this manual, do not attempt to service this product yourself. Opening or removing covers that are marked "Do Not Remove" may expose you to dangerous voltage points or other risks, and will void your warranty. Refer all service issues to qualified service personnel.
13. Unplug this product from the wall outlet and refer to qualified service personnel under the following conditions:
 - a. When the power cord is damaged or frayed;
 - b. When liquid has spilled into the unit;
 - c. When the product has been exposed to rain or water;
 - d. When the product does not operate normally under normal operating conditions. Adjust only those controls that are covered by the operating instructions in this manual; improper adjustment of other controls may result in damage to the unit and

- may often require extensive work by a qualified technician to restore the unit to normal operation;
- e. When the product has been dropped or the cabinet has been damaged;
 - f. When the product exhibits a distinct change in performance, indicating a need for service.

Warranty

Standard Warranty

- Datavideo equipment are guaranteed against any manufacturing defects for one year from the date of purchase.
- The original purchase invoice or other documentary evidence should be supplied at the time of any request for repair under warranty.
- The product warranty period begins on the purchase date. If the purchase date is unknown, the product warranty period begins on the thirtieth day after shipment from a Datavideo office.
- All non-Datavideo manufactured products (product without Datavideo logo) have only one year warranty from the date of purchase.
- Damage caused by accident, misuse, unauthorized repairs, sand, grit or water is not covered under warranty.
- Viruses and malware infections on the computer systems are not covered under warranty.
- Any errors that are caused by unauthorized third-party software installations, which are not required by our computer systems, are not covered under warranty.
- All mail or transportation costs including insurance are at the expense of the owner.
- All other claims of any nature are not covered.
- All accessories including headphones, cables, and batteries are not covered under warranty.
- Warranty only valid in the country or region of purchase.
- Your statutory rights are not affected.

Three Year Warranty

- All Datavideo products purchased after July 1st, 2017 are qualified for a free two years extension to the standard warranty, providing the product is registered with Datavideo within 30 days of purchase.
- Certain parts with limited lifetime expectancy such as LCD panels, DVD drives, Hard Drive, Solid State Drive, SD Card, USB Thumb Drive, Lighting, Camera module, PCIe Card are covered for 1 year.
- The three-year warranty must be registered on Datavideo's official website or with your local Datavideo office or one of its authorized distributors within 30 days of purchase.



Disposal

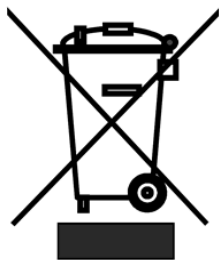

For EU Customers only - WEEE Marking

This symbol on the product or on its packaging indicates that this product must not be disposed of with your other household waste. Instead, it is your responsibility to dispose of your waste equipment by handing it over to a designated collection point for the recycling of waste electrical and electronic equipment. The separate collection and recycling of your waste equipment at the time of disposal will help to conserve natural resources and ensure that it is recycled in a manner that protects human health and the environment. For more information about where you can drop off your waste equipment for recycling, please contact your local city office, your household waste disposal service or the shop where you purchased the product.



CE Marking is the symbol as shown on the left of this page. The letters "CE" are the abbreviation of French phrase "Conformité Européene" which literally means "European Conformity". The term initially used was "EC Mark" and it was officially replaced by "CE Marking" in the Directive 93/68/EEC in 1993. "CE Marking" is now used in all EU official documents.

Chapter 1 Introduction

The HS-2850 is an 8 channel 10-bit 1920 x 1080i & cost-effective, broadcast-quality mobile hand carry switcher. Featuring 8 digital, it is designed for live events and TV programs that need to blend a variety of video and audio sources. HS-2850 is light weight, portable and powerful features for mobile switcher solution.

As a complete AV package, the HS-2850 HD mobile studio enables users to switch seamlessly between video and audio sources and blend high-quality digital content on the fly.

Advanced features include a 17.3-inch multi-image video monitor which displays multiple sources, as well as preview and program.

The system is equipped with an eight way intercom system and is supplied with four belt packs for effective communication between the whole production crew.

The HS-2850 is ideal for TV and video professionals working in outside broadcast or temporary video studios, such as theatres or conference centres. The HS-2850 is also a great value solution for the worship, education and AV market.

That's Datavideo, sharing the value!

1.1 Features

Supports 8 or 12 HD or SD Inputs in a variety of configurations:

- **HD Mode**
 - 8 / 12 HD-SDI
 - 6 / 9 HD-SDI + 2 / 3 HDMI

- **SD Mode**
 - 8 / 12 SD-SDI
 - 6 / 9 SDI + 2 / 3 HDMI
 - 4 SDI
 - 4 SDI + 2 HDMI

- **3 SDI Outputs assignable to:**
 - AUX
 - Program (PGM)
 - Preview (PVW)
 - PGM clean

- **1 HDMI outputs for multi view monitoring**

- **Audio I/O**
 - Input: 4 analogue balanced XLR
 - Output: 2 analogue balanced XLR.
 - Supports embedded audio SDI output from 4-CH XLR Audio input

- **Dual PIP displays with user-defined borders and positions**
- **Two DSK with a setup choice of basic Luma Key or Alpha Channel**
- **Built-in title overlay system (TC-200) that works with CG systems**
- **Cut, Mix and Wipe with borders**
- **Logo and Clock on screen**
- **Cross Point Assignment (XPT)**
- **Audio delay for each de-embedded audio source**
- **OSD SMPTE/ EBU Audio options**
- **Black burst PAL or Tri-Level Sync Reference**
- **Countdown counter on multi screen**
- **Tally, GPI interface and RJ45 for firmware upgrade**
- **Built-in 8 Channel Intercom System**
- **DC 12V operation voltage, available for mobile use**
- **One 17.3-inch monitor with a resolution of 1600x900 dots**

1.2 System Diagram

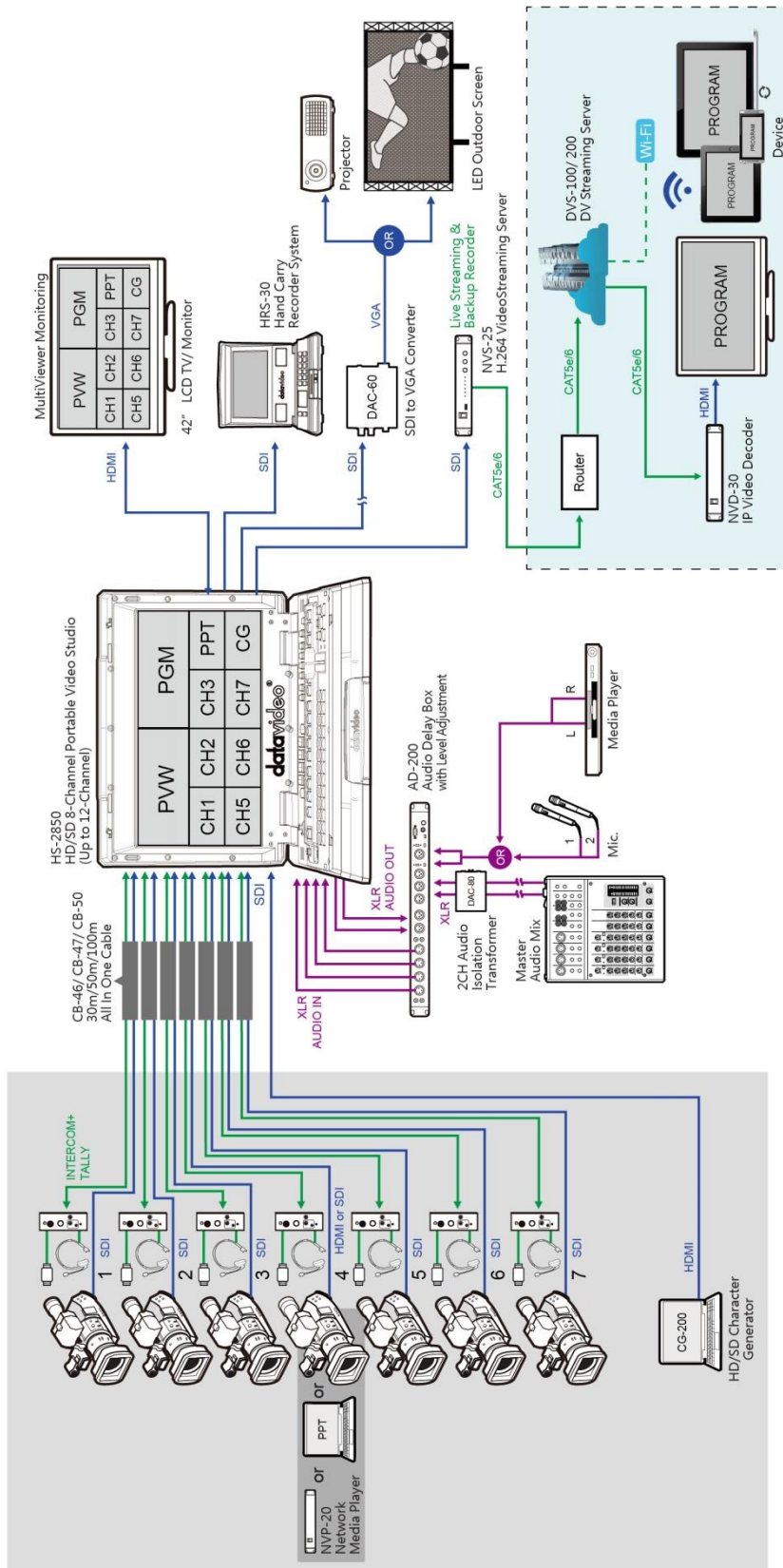

Chapter 2 Connections and Controls

2.1 Main Unit – Rear Panel Overview

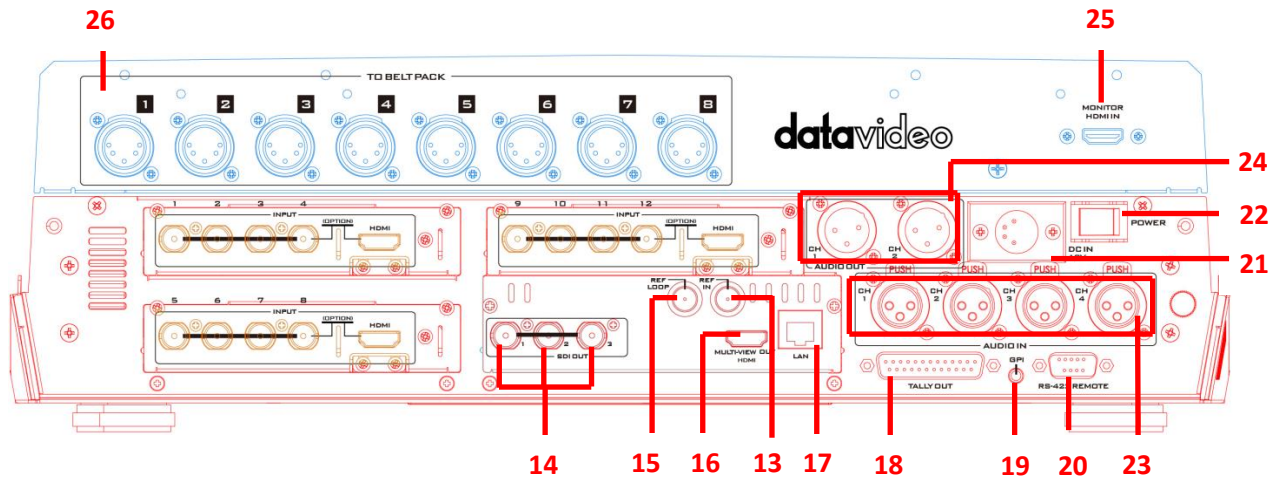

1.	Input 1 – SD / HD-SDI	14.	User Defined SDI Outputs 1~3
2.	Input 2 – SD / HD-SDI	15.	Sync Output / Ref Loop
3.	Input 3 – SD / HD-SDI	16.	User Defined Multi view Output
4.	Input 4 – SD / HD-SDI / HDMI	17.	Ethernet port for PC control & updates
5.	Input 5 – SD / HD-SDI	18.	Tally Output connector
6.	Input 6 – SD / HD-SDI	19.	GPI connector
7.	Input 7 – SD / HD-SDI	20.	RS-422 connector
8.	Input 8 – SD / HD-SDI / HDMI	21.	4pin XLR Power Input connector
9.	Input 9 – SD / HD-SDI**	22.	Power Switch
10.	Input 10 – SD / HD-SDI**	23.	3pin XLR Audio Inputs
11.	Input 11 – SD / HD-SDI**	24.	3pin XLR Audio Outputs
12.	Input 12 – SD / HD-SDI / HDMI**	25.	Monitor HDMI IN (External Video Input)
13.	External Sync Input	26.	To Beltpack

** Please note inputs 9 to 12 are not present if you have purchased the eight channel HS-2850. Eight channel units can be upgraded to twelve inputs, please speak with your local dealer.

2.1.1 Rear Panel Connections

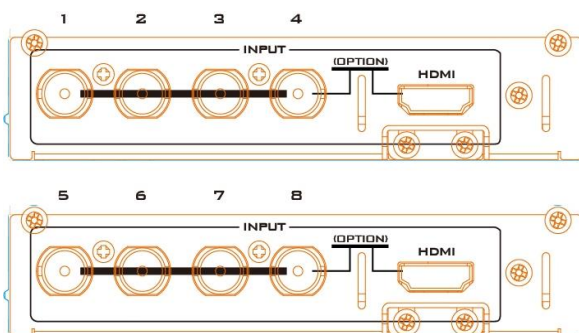

Video Input Modules (1 – 12)

The HS-2850 can be supplied with eight or twelve video input channels.

An HS-2850 with **eight** input channels (**Input 1 to 8**) has two video input modules installed.

There are four video input channels on each Video Input Module. Each Video Input Module (shown left) has the same connections, four BNC connectors and one

HDMI port. The fourth BNC connector and the HDMI port are an option for the same input channel.

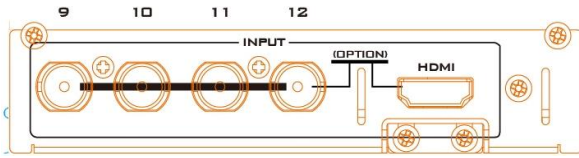

An HS-2850 with **twelve** input channels has three video input modules installed. An eight channel unit can be upgraded to twelve inputs by adding another **Video Input Module (Input 9 to 12)**.

1920x1080i HD Inputs	HD-SDI BNC	HDMI
1, 5 & 9	Yes	---
2, 6 & 10	Yes	---
3, 7 & 11	Yes	---
4, 8 & 12	Yes	Yes

The two tables, on the left, show which types of video inputs can be connected to the HS-2850 switcher. For example, only input channels 4, 8 and 12 have the HDMI input option.

NOTE: This switcher cannot accept 1080P or 1280x720P or 1440x1080i inputs and has no computer input scaling options.

SD Inputs	SDI BNC	HDMI
1, 5 & 9	Yes	---
2, 6 & 10	Yes	---
3, 7 & 11	Yes	---
4, 8 & 12	Yes	Yes

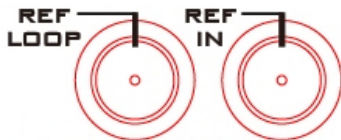

SYNC I/O (13 / 15)

The HS-2850 can be synchronized with other studio equipment such as cameras and House sync. Input BNC (**13**) will accept House sync or Tri-level sync. Output BNC (**15**) can be used to pass the sync signal to other studio equipment such as cameras or recorders.



HDMI MULTIVIEW OUT (16)

The HS-2850 has one HDMI outputs (**16**) which can be used to display a preset combination of inputs plus program and preset.

See the section on ***HDMI Multi-View*** for the five preset multi-view options.



SDI VIDEO OUTPUTS (14)

The **three** BNC output connectors (**14**) are user defined SDI outputs. Each of these SDI outputs has the option to be:

1. Program output
2. Preview output
3. Program output without logo
4. Program output without logo and DSK
5. Aux output of a selected input channel

SDI outputs 2 and 3 also have the option to be a Program output which has been downscaled from HD to SD resolution.

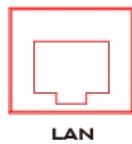

ETHERNET PORT (17)

This RJ45 Ethernet port (**17**) is used to connect the HS-2850 to a PC for remote control, or to update the unit's firmware, or to configure the switcher. See [Chapter 3](#) for more details.

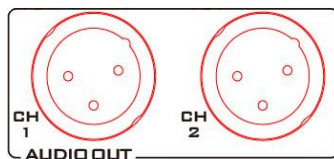

AUDIO OUT (24)

Supports two channels of the XLR Balanced Audio output.

See [Chapter 5 Audio Function](#) for more details.



AUDIO IN (23)

Supports four channels of the XLR Balanced Audio Input.

See [Chapter 5 Audio Function](#) for more details.

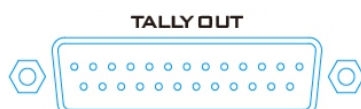

TALLY OUT (18)

The HS-2850 Tally Output port provides bi-colour tally information to a number of other Datavideo products, such as the ITC-100 eight channel talkback system or the Datavideo TLM range of monitors.

See [Appendix 1](#) for more details.



GPI (19)

The GPI socket can be used for simple external control.

See [Appendix 2](#) for more details.

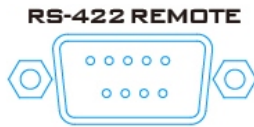

RS-422 REMOTE (20)

In addition to the Ethernet port for remote control, you can also connect your PC to this port for controlling the HS-2850 with the SE Remote software. See [Section 2.2.8 SE Remote Control Software](#) for details.

Please check with your local Datavideo office for advice on this connection or refer to [Appendix 4](#) of this manual for RS-422 PIN definitions and cable wiring.

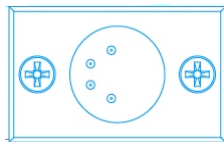

DC IN (21)

Connect the supplied 12V 5A PSU to this 4pin XLR socket.

Pin 1 = GND (-)

Pin 2 = NC

Pin 3 = NC

Pin 4 = VCC (+)

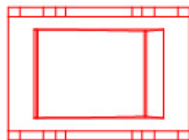

Power Switch (22)

The power switch turns **ON/OFF** the unit.

TO BELTPACK (26)

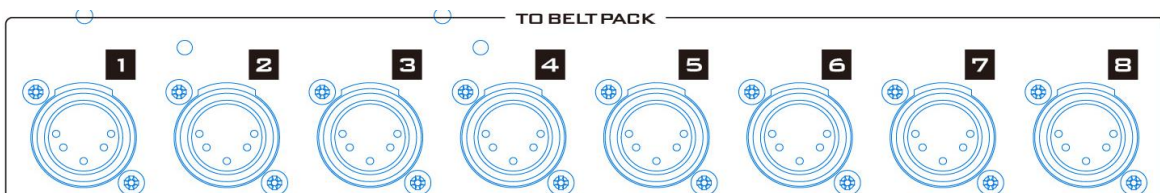

Intercom Channel Input / Output XLR Sockets

Each of the 8 channels has an XLR connector that carries bi-directional signals between the ITC-150 and ITC-100SL. All connections are contained within one cable.

2.2 Control Panel Overview

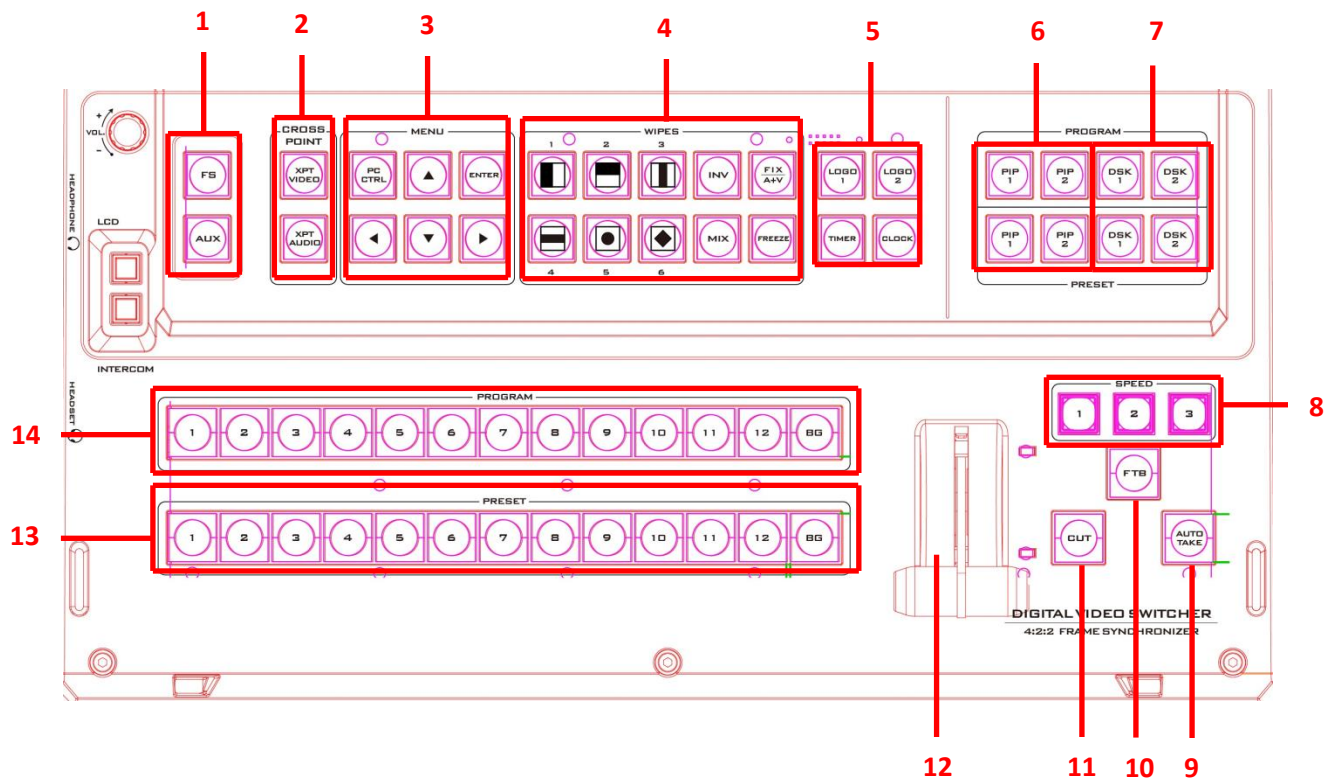

1.	Frame Store & AUX button	8.	Speed Selection
2.	Crosspoint buttons	9.	AUTO TAKE
3.	PC / Menu control	10.	FTB – Fade To Black
4.	Transition selection	11.	CUT
5.	Logos 1 & 2, Clock & Timer	12.	T-Bar – Manual Transitions
6.	PIP selection PST & PGM	13.	Preset Row (PST)
7.	DSK selection PST & PGM	14.	Program Row (PGM)

2.2.1 Video Switching

Program and Preset rows

The Program row of buttons is the active channel, this is the live output. The active channel will appear as the Program Output (PGM). You can switch or CUT from one video source to another directly on the Program row. You will see the multi view PGM output change as you press different keys along this top row of buttons.

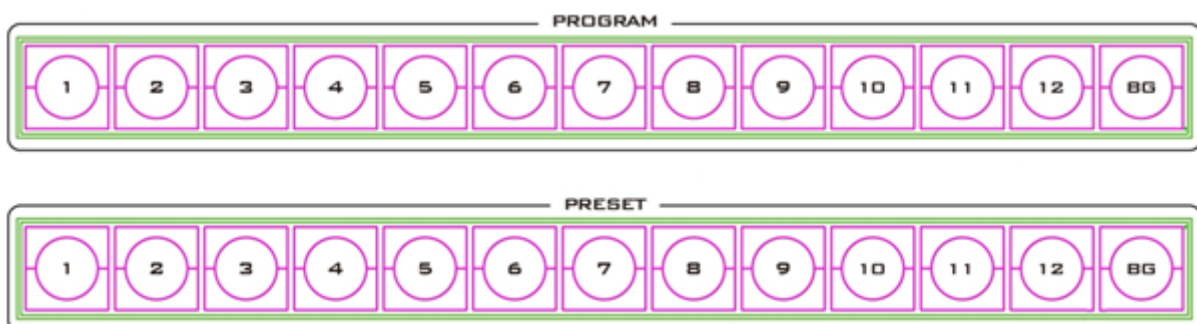

The Preset row is the cued channel, this channel will appear in the PST or Preview window. The Preset row selection decides which input will be transitioned next when using any of the transition controls.

Note: The keys on the Program and Preset rows will be inactive while the T-Bar is active or moving. Only when the T-Bar is fully up or fully down will the keys respond.

Background



The **Background** button assigns a background colour or SMPTE 75% bars for use on the Program and Preset row.

2.2.2 Video Transitions

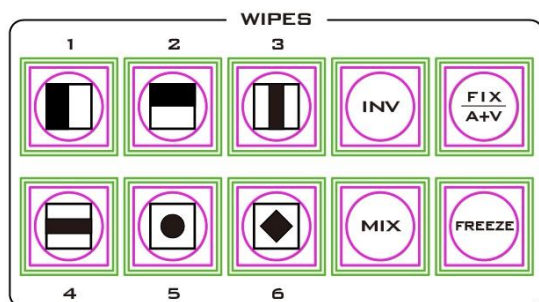

The HS-2850 features six user defined wipe buttons, an A/B dissolve or **MIX** button, an **INV** or Invert wipes button and a **FREEZE** button.

All wipes can have an optional colour border applied. The wipe border width and colour are chosen within the menu system.

Transitions can be performed manually using the T-Bar or automatically by using the **SPEED** and **AUTO TAKE** buttons.

Transition Selection



1. Vertical Wipe Left to Right.



4. Horizontal Wipes from Centre to Top and Bottom.



2. Horizontal Wipe Top to Bottom.



5. Circle Wipe from Centre to outside edges.



3. Vertical Wipes from Centre to Left and Right sides.



6. Diamond Wipe from Centre to outside edges.



INV
Invert the selected wipe so it travels in the opposite direction.



FIX / A+V
Switch the audio mixing option between **Audio Fixed** and **Audio-F-Video (A+V)**.



MIX
Pressing this button selects a basic **A/B Dissolve** for the next transition.



FREEZE
Freeze the program source image or return to live video of the selected program source.

Transition Effect Indication

The selected transition will be indicated in the status area of the HDMI multi-view output. When the **INV** button is pressed, the six wipe icons change to their opposite direction icon.



Triggering the Transition

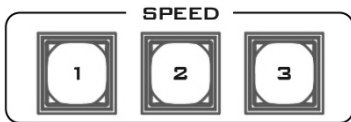

SPEED

There are three speed buttons which can be defined by the user. By pressing a speed button the user is choosing the rate of transition or time taken when using the **AUTO TAKE** button.



AUTO TAKE

This performs an automated switch from the current program source to the selected preset source. The selected transition wipe or dissolve will also be used. The timing of the transition is set by the chosen Speed button.



CUT

This performs a simple immediate switch from the current main source to the selected sub source. The selected transition wipe or dissolve is not used.

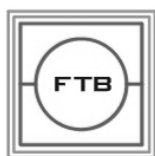

FTB

Fade To Black, this button fades the current video program source to black. When pressed again it acts in reverse from complete black to the currently selected program video source.

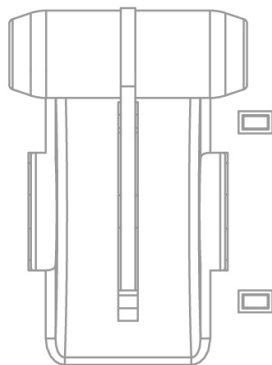

T-Bar

This performs a manually controlled transition from the current program source to the selected preset source. The selected transition wipe or dissolve will be used. When the **T-Bar** has travelled as far as it can go, the transition between sources is complete. The **T-Bar** has indicators next to it, which light when the transition is complete.

The **T-Bar** can be operated in one of two modes which is chosen by a menu option, see the section on **OSD MENU options** for more details.

2.2.3 Logo and Clock



The HS-2850 has the ability to store six static logos and one dynamic logo. The logo files are transferred to the HS-2850 from a Windows PC using the Ethernet connection and the supplied **SEConfig software**. See [Chapter 3](#) for more details on using this software.



LOGO 1

The **LOGO 1** and **LOGO 2** buttons are used to display pre-selected logos on the HS-2850 Preset and Program outputs.

When the button is active the selected logo is shown. These logos are selected from the switcher's memory and positioned using a menu option see the section on [OSD MENU options](#) for details.

LOGO 2 or CLOCK

The user cannot display **LOGO 2** and **CLOCK** at the same time. Instead use **LOGO 1** and **CLOCK** together or use **LOGO 1** and **LOGO 2** together.

The clock time can be synchronized with a computer or set manually using a menu option. The colour and font used in the clock digits can be changed using the supplied **SEConfig software**. See [Chapter 3](#) for more details on using this software or see [OSD MENU Options](#) onwards for the Clock menu options.

TIMER

In some mixing or switching applications it is useful to have a countdown timer. It could be that the input is a pre-recorded video clip and you need to know when to be ready to switch away from it.

This countdown timer function is only seen in the status area of the HDMI multi-view output to the right of the normal Clock function. The timer can be selected for one input channel, several channels or all channels.

When the **TIMER** button is active and the user switches to a selected input channel, the countdown starts on the HDMI multi-view.

The value of the countdown, in minutes and seconds (**MM:SS**), is set by a menu option. Whilst the countdown is in progress, **T-Bar** operation is ignored.

When the countdown reaches zero, the user can then switch or transition to another input channel. If the countdown reaches zero the switcher will not automatically change to the selected Preset source.

2.2.4 Picture-in-Picture and Downstream Key

PIP Preset and PIP Program

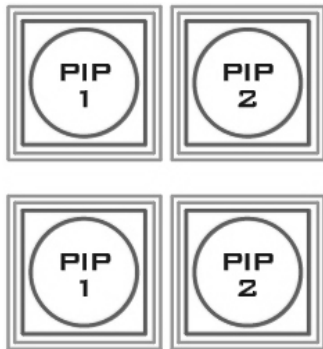

When looking at the top right corner of the HS-2850 Control Panel / Keyboard there are four PIP keys. These are labelled Program and Preset. The upper **PIP1** and **PIP2** keys relate to activating Picture In Picture images on the Program outputs. The lower **PIP1** and **PIP2** keys relate to activating Picture In Picture images on the Multi-view or Preview outputs.

Assigning a video source input to a PIP

Using the lower **PIP1** or **PIP2** buttons you can assign a selected video input to the chosen PIP video layer.

1. First press and hold down the required **PIP** button on the lower row. The Preset row of input sources will light.
2. While still holding down the **PIP** button, press to select the required input from the Preset row.
3. The input will flash to confirm it is selected.

This selection will also be confirmed on the HDMI Multi-view, with a PiP1 or PiP2 label shown next to the selected input image.

The full PIP process is described in the section on [**Picture-In-Picture Function**](#).

DSK Preset and DSK Program

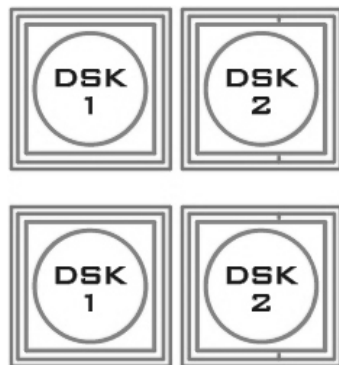

When looking at the top right corner of the HS-2850 Control Panel / Keyboard there are four DSK keys. These are labelled Program and Preset. The upper DSK1 and DSK2 keys relate to activating Down Stream Keying on the Program outputs. The lower DSK1 and DSK2 keys relate to activating Down Stream Keying on the Multi-view or Preview outputs.

Assigning an input to a DSK channel for keying

Using the lower DSK1 or DSK2 buttons you can assign a selected video input to the chosen DSK video layer.

1. First press and hold down the required DSK button on the lower row. The Preset row of input sources will light.
2. While still holding down the DSK button, press to select the required input from the Preset row.
3. The input will flash to confirm it is selected.

This selection will also be confirmed on the HDMI Multi-view, with a T1 or T2 label shown next to the selected input image.

The full DSK process is described in the section on [**DSK Settings**](#).

2.2.5 Frame Store and Audio Control



FS – Frame Store Button

The HS-2850 has eight or twelve video channels, depending on the number of inputs it has. Each of these channels has its own Frame Store, making a total of eight or twelve Frame Stores. Each of these Frame Stores can hold one still image. This still image can be called into the production by using the FS button located at the top left corner of the HS-2850 Control Panel / Keyboard. The FS button allows the user to toggle between the still image of the Frame Store or the live video input also connected to that same video channel.

How to choose live video input or Frame Store

1. First press and hold down the FS button. The Preset row of input sources will light.
2. While still holding down the FS button, press the required input on the Preset row.
3. The input button will flash to confirm the Frame Store is selected.

This selection will also be confirmed on the HDMI Multi-view, with the selected channel showing the live input or frame store image.

The content of each Frame Store is uploaded to the HS-2850 from a PC. The supplied **SEConfig** software is used to do this. The file upload process is described in **Chapter 3**.



AUX Source Selection

The auxiliary output (AUX) allows you to fix the SDI output onto a particular input source. The HS-2850 has **four** user defined SDI outputs, see **Section 2.1.1** item 14. One or all of these outputs can be set up as an auxiliary (AUX) output via a menu option. See **OSD MENU Options** onwards for details.

The AUX output source can be quickly selected in the following way.

1. First press and hold down the AUX button. The Input 1 and 2 buttons of the Program row will light up red.
2. While still holding down the AUX button, press either the Input 1 button or the Input 2 button on the Program row.
3. The pressed input button (1 or 2) on the Program row will now flash red along with one of the input buttons on the Preset row flashing green. The rest of the input buttons on the Preset row will remain solid green.
4. The green flashing button on the Preset row indicates the selected source of the AUX output. To change the source, simply press other input buttons.

When you see the selected input button flashing green, your AUX output source is now assigned and you may release the AUX button to complete the AUX source selection.

2.2.6 Crosspoint

The **CROSSPOINT** function allows you to cross assign input channels to program/preset row buttons. Follow the steps outlined below to assign video input channels to the program/preset row buttons according to your preference.



XPT Video

Assigning video source, and channel setting according to your preference.

The XPT Video source can be quickly selected in the following way.

1. First press and hold down the **XPT VIDEO** button. The Program row of input sources will light.
2. While still holding down the **XPT VIDEO** button, press the required input on the Program row.
3. After pressing the required input on the program row, the Preset row of input sources will light. While still holding down the **XPT VIDEO** button, press the required input on the Preset row.
4. The input button will flash to confirm the video source is selected.

Note: If you associate one video input channel to more than one program/preset row buttons, you will only see the input video correctly displayed on the video channel window associated with the first program/preset row button that you assign the video input channel to and the rest of the video channel windows will display corrupted images. To avoid this, make sure your XPT setting is configured to **one-input-to-one-button** configuration.

For example, if you assign video input channel 1 to button 2 of the program row, remember to swap the original video input channel associated with program button 2 with video input channel 1.

The same procedure can be applied to audio channel sources as well. Follow the steps described below to cross assign audio input channels to program/preset row buttons.



XPT Audio

Assigning audio source, and channel setting according to your preference.

The XPT Audio source can be quickly selected in the following way.

1. First press and hold down the **XPT AUDIO** button. The Program row of input sources will light.
2. While still holding down the **XPT AUDIO** button, press the required input on the Program row.
3. After pressing the required input on the program row, the Preset row of input sources will light. While still holding down the **XPT AUDIO** button, press the required input on the Preset row.
4. The input button will flash to confirm the audio source is selected.

2.2.7 OSD MENU Options

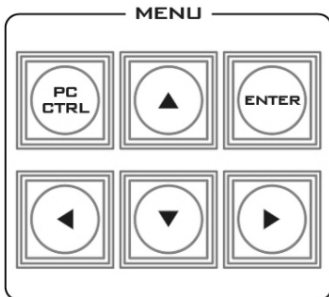

When the **ENTER** button is pressed the Main Menu list is displayed on the HDMI 1 Multi-view output.

This section covers the Menu options in the order that they appear on the HS-2850 HDMI 1 Multi-view. These settings may also appear in more detail elsewhere in this instruction manual. Options may vary depending on the firmware version in use.

Once the chosen setting has been confirmed with the **ENTER** button it is stored within the switchers non-volatile memory.

Version Number		
Version Number xx.xx where xx.xx is the firmware version number.		
Base Standard		
1080i50Hz	Tick selection for ON or OFF	
1080i60Hz		
1080i59.94Hz		
<p>Note: When Output Standard & Format is set to the option HD SDI 1080p (25/29/30):</p> <p>1. The Output will be automatically adjusted to 1080p25Hz if 1080i50Hz is selected for Base Standard.</p> <p>2. The Output will be automatically adjusted to 1080p29Hz if 1080i59.94Hz is selected for Base Standard.</p> <p>3. The Output will be automatically adjusted to 1080p30Hz if 1080i60Hz is selected for Base Standard.</p>		
Audio Dynamic Range		
Audio Dynamic Range	24	
	18	
Audio Tract		
EXTERNAL ANALOG AUDIO	Tick selection for ON or OFF	
AUDIO PASS THROUGH		
On Preview Video Adjustment		
Brightness	72 to 184, default 128	Select the input that you want to adjust in the PVW window. This is a fine adjustment, the change happens gradually as the value is increased or reduced.
Contrast	36 to 92, default 64	
Saturation	36 to 92, default 64	
Aperture	0 to 3	
Y-C Delay	0 to 7	
Set to Norminal	Reset to default values	
Video Input Standard and Format		
Inputs 1,2,3,5,6,7,9, 10&11	Can be a choice of: HD SDI 1080i * HD SDI 1080p (50/59/60Hz) * HD SDI 1080p (25/29/30Hz) * HD SDI 720p (50/59/60Hz) * SD SDI 4:3 SD SDI 16:9	
Inputs 4,8 &12	Can be a choice of HD SDI 1080i * HD SDI 1080p (50/59/60Hz) * HD SDI 1080p (25/29/30Hz) * HD SDI 720p (50/59/60Hz) * SD SDI 4:3 SD SDI 16:9 HD HDMI 1080i HD HDMI 1080p (50/59/60Hz) HD HDMI 1080p (25/29/30Hz) HD HDMI 720p(50/59/60Hz) SD HDMI 4:3 SD HDMI 16:9 HDMI COLOR MODE: RGB / YUV 4:2:2 / YUV 4:4:4 / CG-200	

	MODE <i>*All HD inputs are natively 16:9 aspect ratio.</i>	
On Preview Audio Level and Delay		
Level	Range +60 to -60	
AUDIO DELAY	Range 0 to 16	
Nominal	Resets value to 00	
SDI De-Emb. Audio Group / Pair		
Input 1 – 12	User choice of GROUP: 1-4 PAIR: 1-2	
HDMI De-Emb. Audio Group		
Input 4 / 8 / 12	User choice of GROUP 1 / 2 / 3 / 4	
Outputs SDI Re-Emb. Group		
Output 1 / 2 / 3 / 4	User choice of GROUP 1 / 2 / 3 / 4	
Auto Audio Mixing Type		
X-Type	Tick selection / X type = A/B cross fade	
V-Type	Tick selection / V type = Fade out A then Fade in B	
T-Bar Audio Mixing Type		
Follow Auto (X or V) Type	Tick selection / use the option enabled in Auto Audio Mixing Type	
By the End	Tick selection / clean cut or immediate audio switch	
PIP Set Up		
Position PIP 1	Horizontal Position (Left to Right)	000-097
	Vertical Position (Lower to Upper)	000-108
Size PIP 1	1 (Small) – 33 (Large)	
Border PIP 1	Width	00-05
	Color	1-8 1=White, 2=Yellow, 3=Cyan, 4=Green, 5=Magenta, 6=Red, 7=Blue, 8=Black
Position PIP 2	Horizontal Position (Left to Right)	000-097
	Vertical Position (Lower to Upper)	000-108
Size PIP 2	1 (Small) – 33 (Large)	
Border PIP 2	Width	00-05
	Color	1-8 1=White, 2=Yellow, 3=Cyan, 4=Green, 5=Magenta, 6=Red, 7=Blue, 8=Black
Logo Set Up		
Logo 1	Select	01-08 Logo selection 1 to 7 are still image Logo 8 selection is dynamic moving image

	Horizontal Position (Left to Right)	000-110
	Vertical Position (Lower to Upper)	000-135
Logo 2	Select	01-08 Logo selection 1 to 7 are still image Logo 8 selection is dynamic moving image
	Horizontal Position (Left to Right)	000-110
	Vertical Position (Lower to Upper)	000-135
Speed Button Set Up		
Speed 1	1-64 (Frames)	
Speed 2	1-64 (Frames)	
Speed 3	1-64 (Frames)	
Wipe Button Set Up		
Button 1-6	WIPE	1-8
	Soft Edge	0-4
	Color	1-8 1=White, 2=Yellow, 3=Cyan, 4=Green, 5=Magenta, 6=Red, 7=Blue, 8=Black
Outputs Mode and Standard		
Output 1/2/3/4	Standard & Format	HD SDI
		SD SDI 4:3
		SD SDI 16:9
		HD SDI 1080p (25/29/30)
	Mode	Program
		Program logo free
		Program logo & DSK free
		Preview
		AUX 1
AUX 2		
DSK Set Up		
DSK 1 / 2	Fill & Key mode	Alpha channel
	Luma Key mode	
	Luma Key level	0 (black) to 255 (white)
BG Color (1-8) and Color Bar (9)		
1-9	Background Color Settings 1=White, 2=Yellow, 3=Cyan, 4=Green, 5=Magenta, 6=Red, 7=Blue, 8=Black, 9 = SMPTE 75% colour bars	
T-Bar Mode		
One Way Mode	= T-Bar operates transition in only one direction	
Two Way Mode	= T-Bar operates transition in both directions	
1kHz to Color Bar		
1kHz to Color Bar	Tick selection for ON or OFF	

Keys Brightness		
1-4	Keyboard button brightness with user choice of 1 to 4 1 = Low, 4 = High	
Multi-Screen Audio Indicators		
Multi-Screen Audio Indicators	Tick selection for ON or OFF	
Reference		
External Mode	Reference	Tick selection for ON or OFF
	HD: Analog 3 Level Signal	Tick selection for ON or OFF
	SD: Composite Signal	Tick selection for ON or OFF
H-Timing	0-255	
Factory Settings		
Factory Settings	Tick selection for ON or OFF	Resets to factory default
Clock Settings		
Horizontal Position (Left to Right)	000-110	
Vertical Position (Lower to Upper)	000-124	
SET Hours	0-23	
SET Minutes	0-59	
Clear Seconds	Tick selection for clearing second	
Multi Screen Mode		
This option relates to the HDMI outputs 1 and 2.		
A: M1=PVW+PGM+3 IN; M2=9 IN		
B: M1=PVW+PGM+12 IN; M2=PGM		
C: M1=PVW+PGM+8 IN; M2=PGM		
D: M1=PVW+PGM+12 IN; M2=M1		
E: M1=PVW+PGM+8 IN; M2=M1		
GPI Settings		
Input Select	00-12	Chosen input number
Time Delay	In frames between 1 to 75	
Mode	Level Mode	Tick selection for ON or OFF
	Pulse Mode	Tick selection for ON or OFF
Countdown Timer Settings		
Input 1-12	Count Down Enable	Each input can be selected for Count Down ON or OFF.
	Down Counter Value	If Count Down is ON then the Down Counter value is set in minutes and seconds (MM:SS) - Max.= 1 Hour or 60:00, Default = 15 Seconds or 00:15
Multi-Screen Audio Source		
Preview Program	Tick selection of Program or Preview audio on the HDMI outputs	
Control Interface		
Ethernet	Tick selection for ON or OFF	
RS422		

2.2.8 PC Control – SE Remote Control Software

It is possible to control the HS-2850 with a Windows 7 computer using an Ethernet connection. The SE Remote software supplied with the switcher needs to be installed on the computer first. The HS-2850 then needs to be placed into PC Control mode. To do this press the **PC Control button** on the HS-2850 Control Panel. Once launched, the Remote software displays an image of the HS-2850's keyboard as shown below. Any active functions or selections will be shown with a red button or key. These buttons or keys can be clicked with a mouse or alternatively you could use a touch screen monitor.

Before launching the SE Remote software, please see [Chapter 3 Switcher Configuration Utility](#) for network setup information.



NOTE: It is not possible to run both the SEConfig and SE Remote software applications at the same time.

SET Function

After the network connection between the PC and the HS-2850 is successfully configured, you can then launch the **SE Remote** software on the PC. Locate **SET** function button which is located just above the T-Bar. When clicked, a new window will open as shown left below. This Settings window is used to match the software to the IP address of the connected HS-2850 switcher.

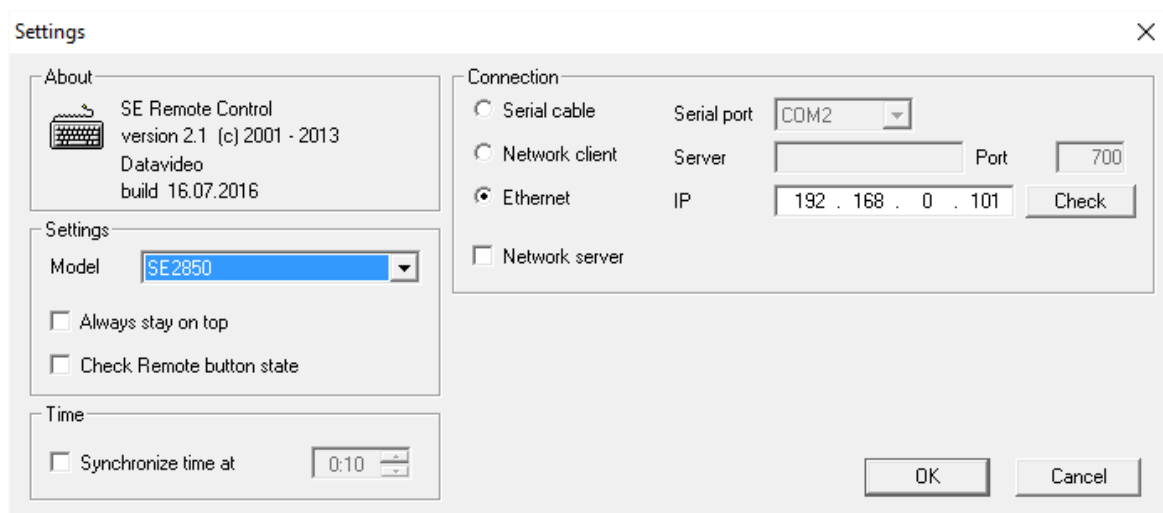

Enter the switcher's IP address and then click the "**Check**" button to determine the switcher model number which is then selected from the "**Model**" pull-down menu. Once configured, click the **OK** button to shut down to "**Settings**" window and the **SE Remote** software should be successfully connected to the HS-2850 as shown in the diagram below.



REC & PLAY Functions

Left mouse click the grey **REC** button and it will light up red. All of your actions when using the Remote Console will now be recorded to file. The only action that will not be recorded is the T-Bar, use the **CUT** or **AUTO TAKE** buttons instead. The function buttons just above the T-Bar as listed on this page are also ignored.

Click the red **REC** button again and a save window will appear. You can now save the recorded actions as a macro text file to a chosen location on the computer.

Click the grey **PLAY** button and a load file window will appear. You can now browse to and load a macro text file. When you load a file the recorded actions will begin to play back until the end of the file.

Software-based Macro Functions

It is possible to record a Macro type playlist to the computer when using the SE Remote software. This Macro function allows these pre-recorded keyboard actions or selections to be played back within a project where timing is important or where the same steps are repeated throughout the production. The Macro function buttons are **REC**, and **PLAY**. These buttons are located just above the T-Bar in the SE Remote display above.

TIME Function

This button is located just above the T-Bar in the SE Remote display above. Mouse clicking on the **TIME** button will synchronize the time on the HS-2850 switcher to the current time on the computer.

2.3 Intercom & Monitor Control Panel

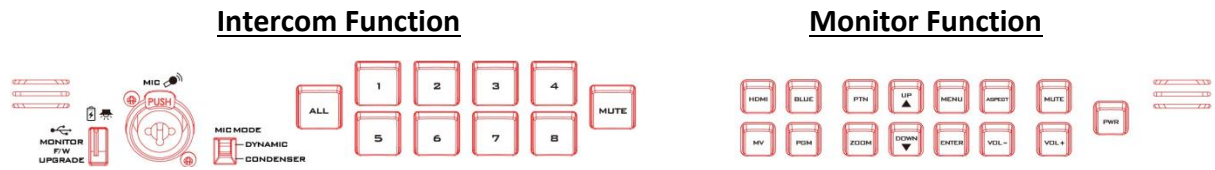

2.3.1 Intercom Function



USB Port

USB port for **LED power supply** and **Firmware Upgrade**.

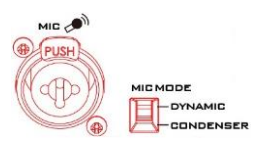

XLR Microphone Socket

Combined XLR / 1/4" (6.3mm) Jack Microphone Input for either a **Condenser** or **Dynamic Gooseneck Microphone**.

- XLR supports Condenser Microphones
- 1/4" (6.3mm) Jack supports Dynamic Gooseneck Microphone



ALL Button

Opens communication with all channels. All channels will hear communication from the operator, or from any other channel using the **TALK** button.

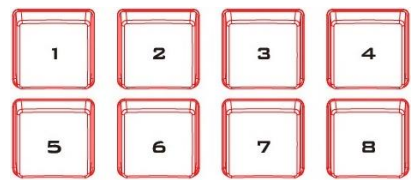

Channel Buttons 1~8

Opens communication with individual channels. More than 1 channel can be active at any given time, active channels are illuminated red.

All active channels will hear any communication from the operator or from any other active channel.

The buttons will also indicate if any channel is paging, the paging channel will flash in orange until the page is answered.



MUTE Button

Mutes all communication from the base station or any channel.

2.3.2 Monitor Function



HDMI, Multiview, PROGRAM

Select the type of input you are using - **HDMI, Multiview, PROGRAM.**

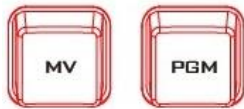

The active input will be indicated by a red LED on the Source Button. When you push the "**HDMI**" button, you select the 17.3" display from the HDMI source input of Rear Panel; it is a full screen display. When you push the "**MV**" button, then you go back to show multi-view so you can switch back & forth between HDMI & Multiview.



BLUE

Press this button to eliminate the red and green component of input signals. Only the blue component of an input is displayed on the screen.



PATTERN

Press the PATTERN Key to activate the colour bar.



ZOOM

The ZOOM Feature Setting Menu allows you to adjust the screen display size.



Menu Navigation Buttons

Display and navigate the set up menus - See Menu Options for more details



UP Button also switches the 4:3 Mask On / Off - (only available in 16:9 modes)



Aspect Ratio Button

Sets the Aspect Ratio to 16:9 / 4:3



Mute Button

Mutes the audio from the internal speakers or headphone socket.



Volume Control & Audio Meter

Adjusts the speaker / headphone volume up / down.



PWR

Switches the TLM-170 Power ON / OFF.

2.3.3 Monitor Menu Options



The HS-2850 Monitor is set up via on screen menus. To display the on screen menu, press the **MENU** button.

The menus are navigated using the **Up / Down** buttons.



Press **Enter** button to enter or exit the menu mode.

Main Options	Sub Options	Parameters	Parameters	
MAIN ADJUST	BRIGHTNESS	0~100		
	CONTRAST	0~100		
	SHARPNESS	0~100		
	SATURATION	0~100		
	TINT	0~100		
	BACK LIGHT	0~100		
	NR	HIGH / MID / LOW / OFF		
	MPEG NR	HIGH / LOW / OFF		
	VOLUME	0~100		
	EXIT			
COLOR Adjust	7500			
	9300			
	6500			
	USER COLOR	RED		0~100
		GREEN		0~100
BLUE			0~100	
EXIT				
SCAN SETTING	UNDER SCAN			
	OVER SCAN			
INFORMATION	H. FREQUENCY			
	V. FREQUENCY			
	RESOLUTION			
	VER.			
LANGUAGE	English [default]			
	Francis			
	Deutsch			

	Español		
	Italiano		
	Dutch		
	Português		
	Russian		
	EXIT		
SPECIAL FUNCTION	OSD TIMEOUT	5-120 SEC	
	FRAME RATIO	90 / 80 / OFF	
	4:3 MARK LINE	ON / OFF	
	CENTRAL MARK	ON / OFF	
	CINEMA ZONE MARK	ON / OFF	
	AUDIO CHANNEL L*	1/2/3/4	
	AUDIO CHANNEL R*	1/2/3/4	
	EXIT		
FACTORY RESET			
EXIT			

* Selectable on PGM only; external HDMI and MV are allowed on 1 and 2 ONLY

MAIN ADJUST

The first menu to be displayed is the MAIN ADJUST Menu.

To access the MAIN ADJUST Menu press enter, the Brightness setting will be highlighted.

To adjust the Brightness press Enter again. Use the Up / Down buttons to change the setting and then press Enter to store the new value and return to the main menu.

To select a different setting (Brightness, Contrast, Saturation, Sharpness, TINT), use the Up / Down buttons. Follow the same procedure to set other values.

COLOR

To access the menu press enter so that Color Adjust option is highlighted

To access the option for the selected color setting, press enter again.

Use the Up / Down buttons to navigate the available color settings.

You can choose:

- 7500
- 9300
- 6500
- USER COLOR

Information

The System Information Menu displays Horizontal Frequency, Vertical Frequency, Resolution and the Firmware Version of the monitor.

Once selected, the information will be displayed as follows:

You will see: H. FREQUENCY 33.7KHZ

V. FREQUENCY	60.0HZ
RESOLUTION	1920X1080I
VER.	0.11

Special Function

The Special Function Menu has settings for the OSD TIMEOUT, Frame Ratio, 4:3 MARK LINE, Central Mark, Cinema Zone Mark and Audio Channel L & R.

To access the options for the selected setting press enter again, so that the option is highlighted

Use the Up / Down buttons to navigate the available options.

You can choose:	OSD TIMEOUT	5-120 SEC
	FRAME RATIO	90 / 80 / OFF
	4:3 MARK LINE	ON / OFF
	CENTRAL MARK	ON / OFF
	CINEMA ZONE MARK	ON / OFF
	AUDIO CHANNEL L*	1/2/3/4
	AUDIO CHANNEL R*	1/2/3/4

Factory Reset

The monitor menu offers a Factory Reset option, which will return all the settings of the monitor to the factory defaults

To reset the monitor press the MENU button and then use the UP / Down button to navigate to FACTORY RESET option. Press ENTER again to reset the monitor. After a few seconds the monitor will be reset.

Chapter 3 Switcher Configuration Utility (SEConfig Software)

The **Switcher Configuration Utility** or the **SEConfig Software** allows you to configure the HS-2850 with a Windows 7 computer using an Ethernet connection. Before launching the Switcher Configuration Utility, make sure it is installed on your computer.

3.1 Network Setup

Before you attempt to establish connection between PC and your HS-2850, you have to manually configure the PC network settings first. Follow the steps outlined below to assign a static IP address to your PC.

- (1) Connect the PC to the HS-2850 switcher using an Ethernet cable.
- (2) Turn on the PC and the HS-2850.
- (3) The HS-2850 then needs to be placed into PC Control mode. To do this press the **PC Control button** on the HS-2850 Control Panel or keyboard.
- (4) Find the switcher’s IP address using the **SEConfig software**. Double click the **SEConfig software** icon to open the **Switcher Configuration Utility** program.
- (5) The **Find button** within the **SEConfig software** will help confirm the IP address of the switcher. See later sections in this Chapter for more information on **SEConfig**. In the example below, the IP address of the switcher is **192.168.0.101**.

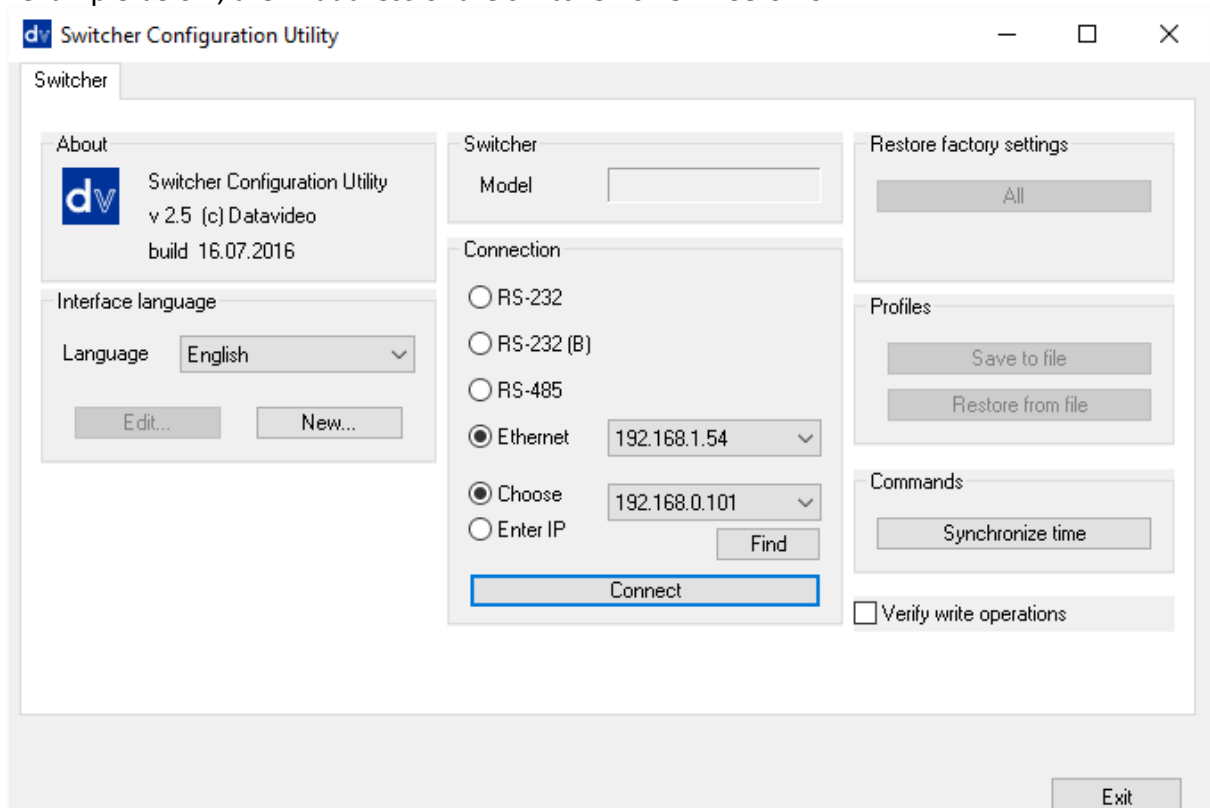

- (6) Once you have obtained the switcher’s IP address, go to **Control Panel**, open **Network and Sharing Center** and then click **Ethernet**.

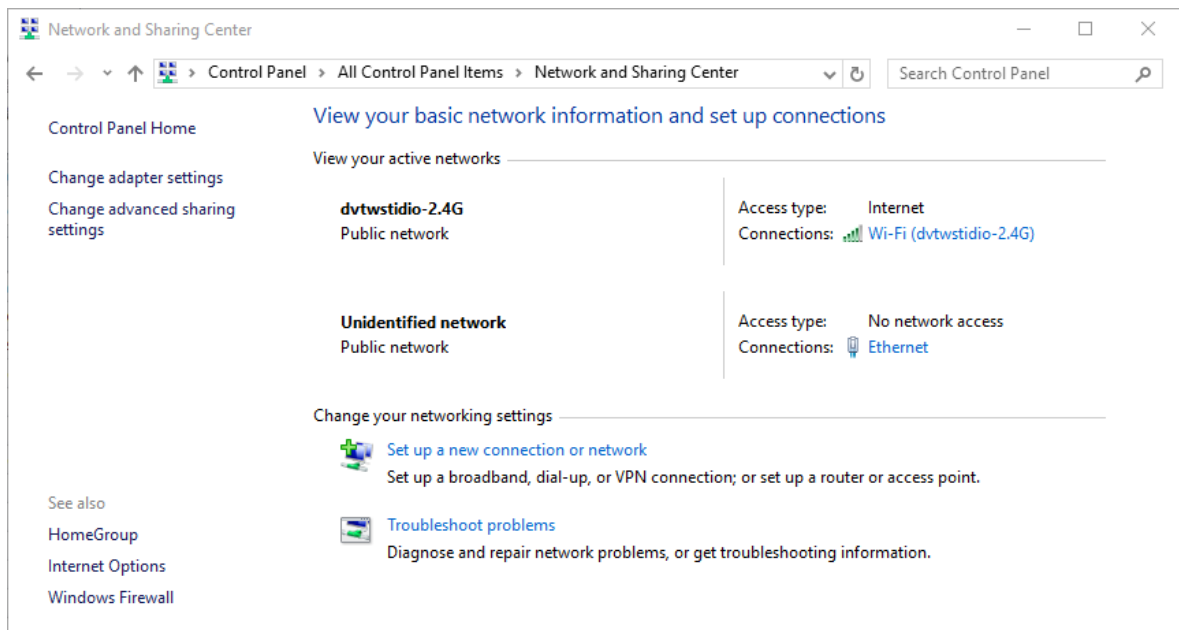

(7) On the **Ethernet Status** Window, click the **Properties** button.

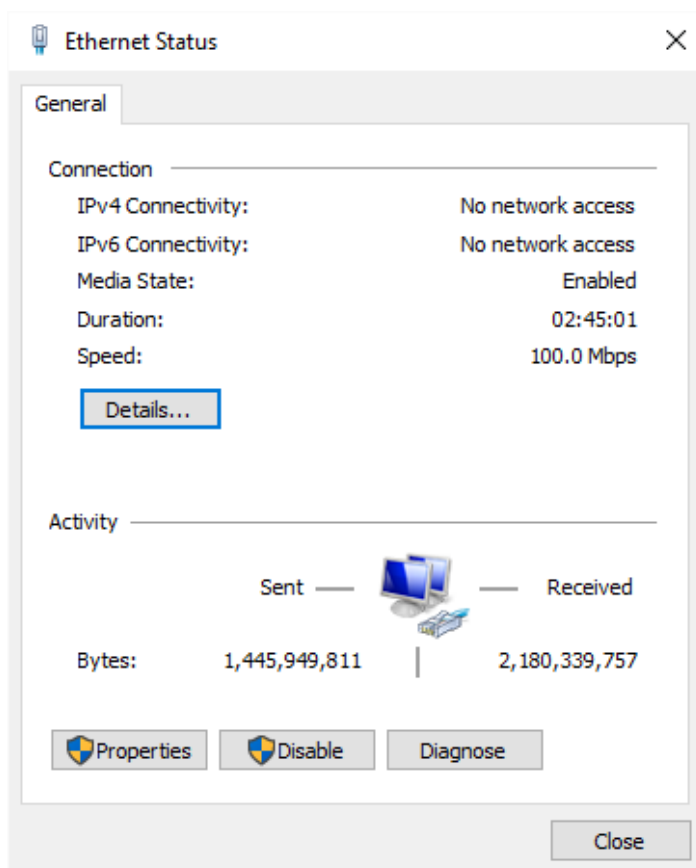

(8) On the **Ethernet Properties** window, double click **Internet Protocol Version 4 (TCP/IPv4)** to open a window on which you will be allowed to manually enter an IP address for your PC.

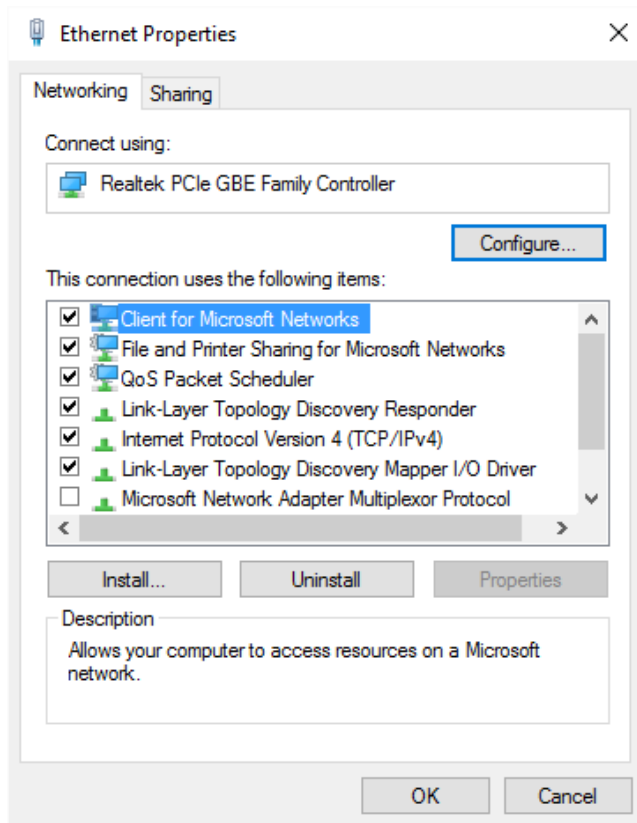

- (9) Please remember that the PC used must be in the same IP network as the HS-2850. So the first three octets (numbers) in the IP Address field must match the first three octets of the switcher IP address. The fourth octet should be a different number for the PC and switcher. In the example below, we have entered an IP address of 192.168.0.100 with the Subnet Mask of 255.255.255.0.

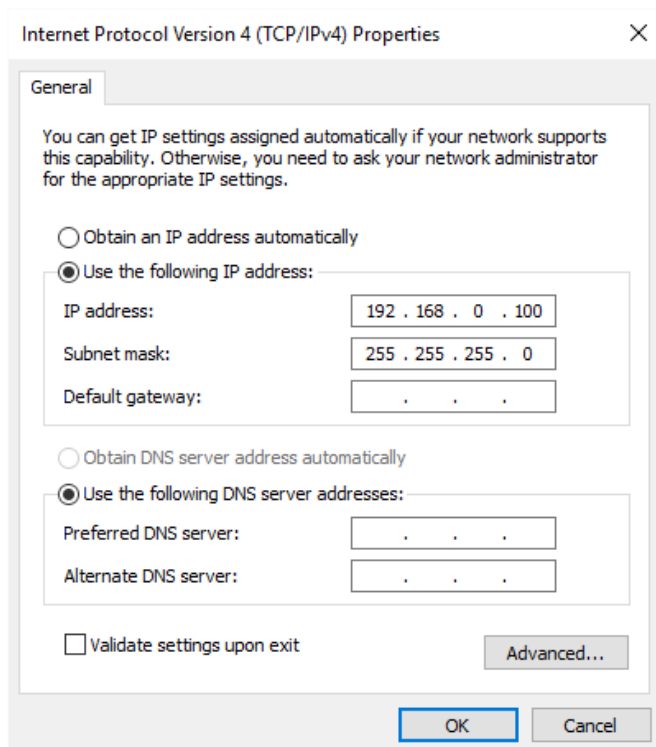

Note: To reset the IP Address of the PC/laptop use the **Network and Sharing Center** option in Windows 7 **Control Panel**. Click on **Local Area Connection** then **Properties**. Click to highlight **Internet Protocol Version 4 (TCP/IPv4)** then click **Properties** again. Then click **Use the following IP address**.

3.2 Connecting the SEConfig Software to the Switcher

1. Double click the **SEConfig** DV icon to launch the application.

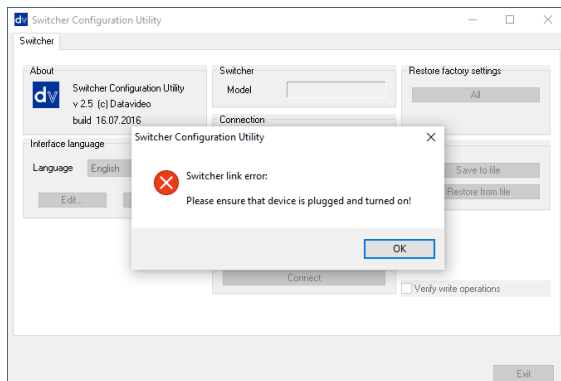

2. If you immediately get an error window, do not worry, this just means the **“PC Control”** button in the **MENU area** of the HS-2850 keyboard has not been enabled.

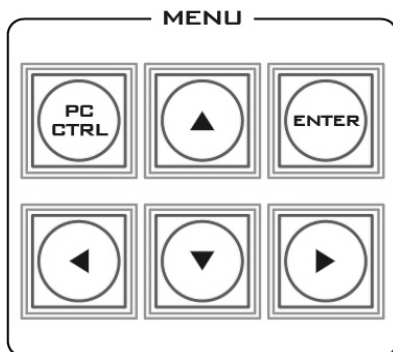

3. Make sure the **“PC Control”** button is enabled and then click **OK**.

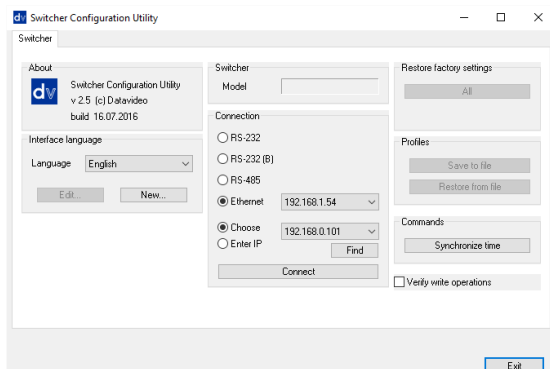

4. Select **Ethernet** to display the Computer’s IP Address. Click the **Find button** to find and display the HS-2850 Switcher’s IP Address in the drop down list. The first three numbers in both IP addresses should match. See the example on the left.

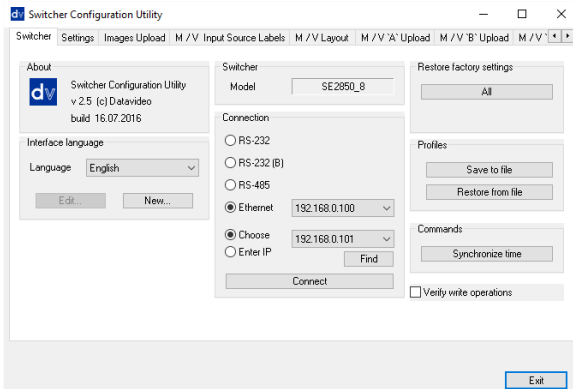

5. Click **Connect** and additional function tabs will immediately become available at the top of the application window. These are:
- Switcher
 - Settings
 - Images Upload
 - M/V Input Source Labels
 - M/V Layout
 - M/V 'A' Upload
 - M/V 'B' Upload
 - M/V 'C' Upload

3.2.1 Change the Switcher IP Address



The **Switcher Network Setup Utility** allows the user to change the switcher IP address. Locate, on your desktop, the icon as shown in the diagram below and then double click it to open the utility software.

After the **Switcher Network Setup Utility** is opened, you will see the following **SE Network Setup** window on the screen.

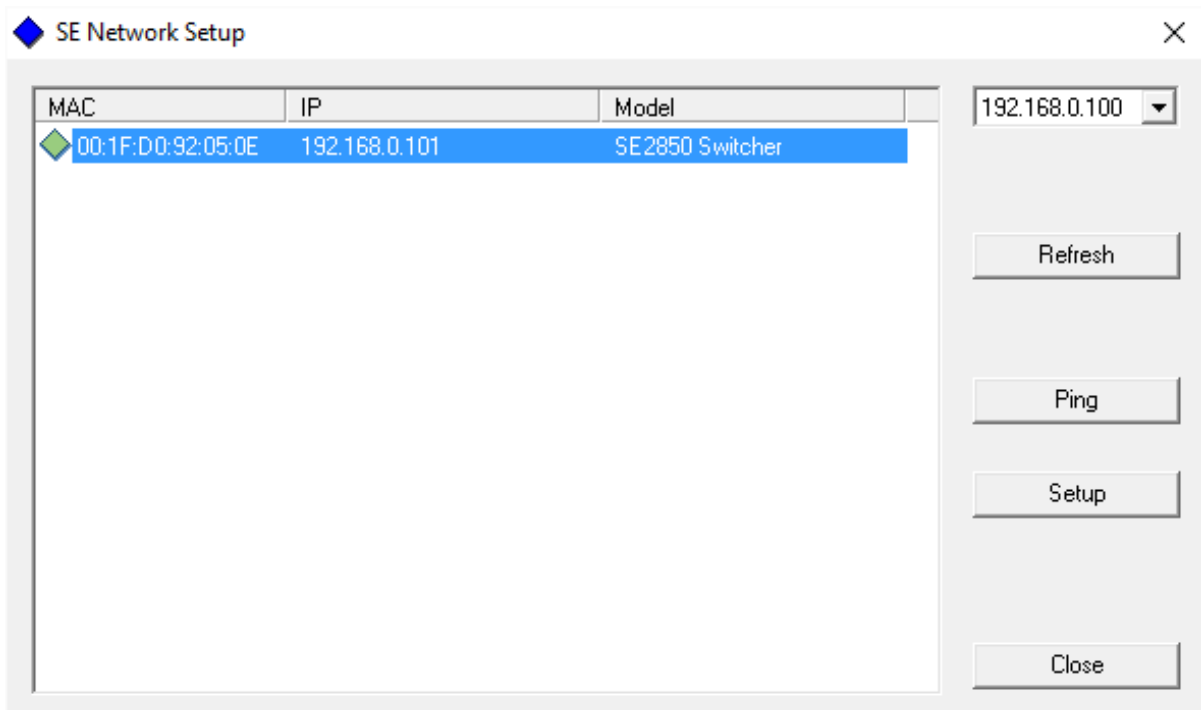

To change the IP address, click the **Setup** button to display the Network Parameters as shown in the diagram below. Update the network parameters accordingly.

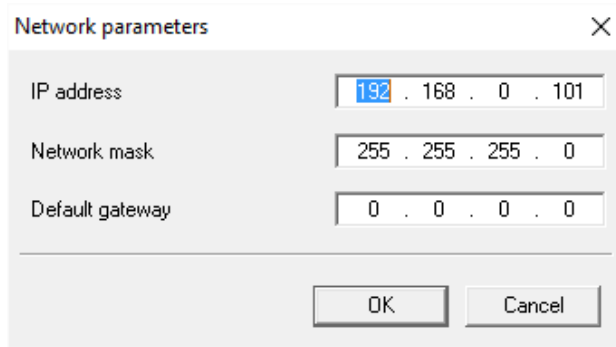

Use the network **PING** feature to check if the IP change is successful. You will get the **PING** reply from the switcher if the IP is valid and the connection has been successfully established.

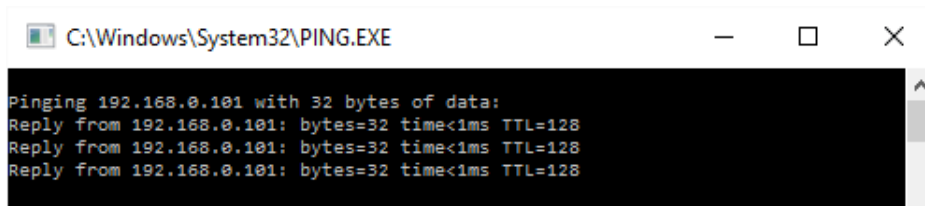

3.3 Switcher tab

This first tab can be used to choose the method of connection between the computer and the switcher. In this case the HS-2850 is connected using selected Ethernet IP addresses.

Note that the first three numbers in the IP addresses of the switcher and computer should be the same. The last number in each IP address should be unique.

If you are connecting for the first time you may be asked by the computer to change the firewall setting to allow this application to connect to the switcher.

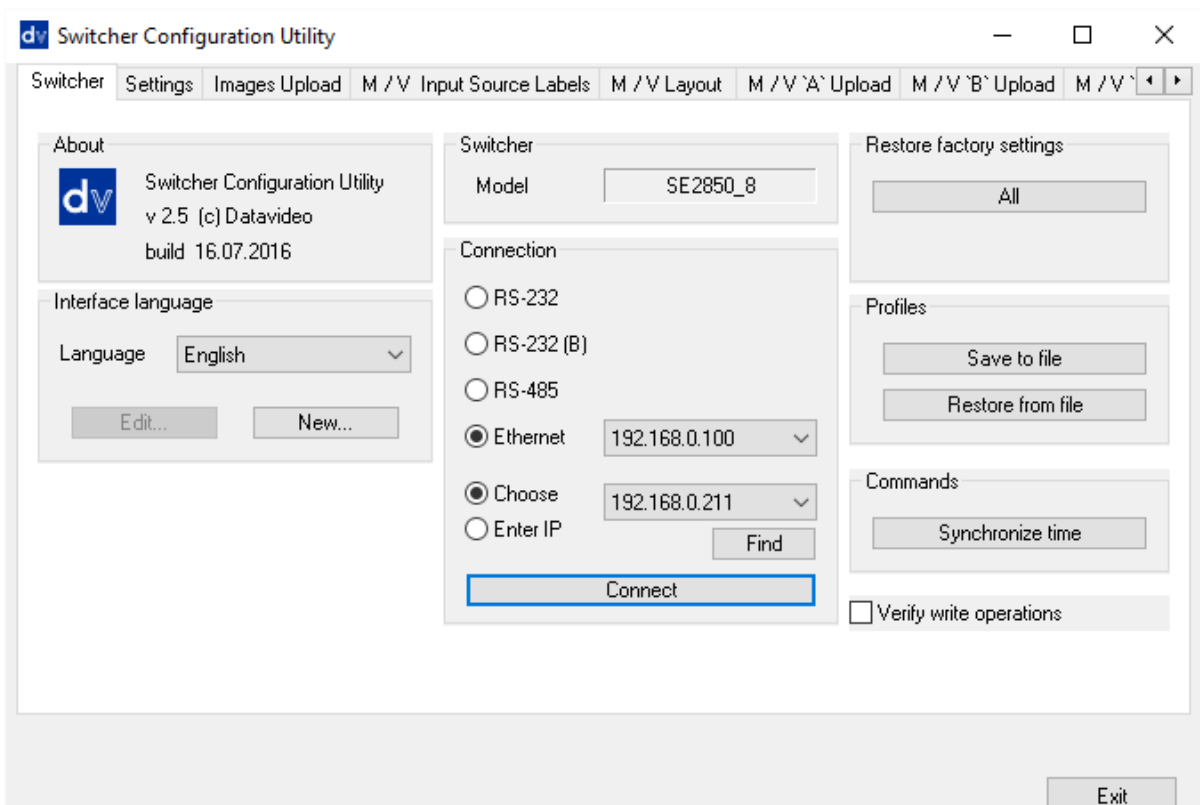

3.3.1 Profiles

It is possible to store the current profile or settings of the switcher to your computer. This file can then be restored to the machine at a later date allowing simple configuration of the unit. Depending on the included levels of the profile this save process may take some time to complete.

3.4 Settings tab

The settings tab is another way to change the menu settings of the switcher. The options may appear in a slightly different order from those in the onscreen menu described in [Section 2.2.7](#).

Each menu option in the left hand pane can be expanded by clicking on the plus sign in the left hand pane. The right hand pane shows any values which can be changed.

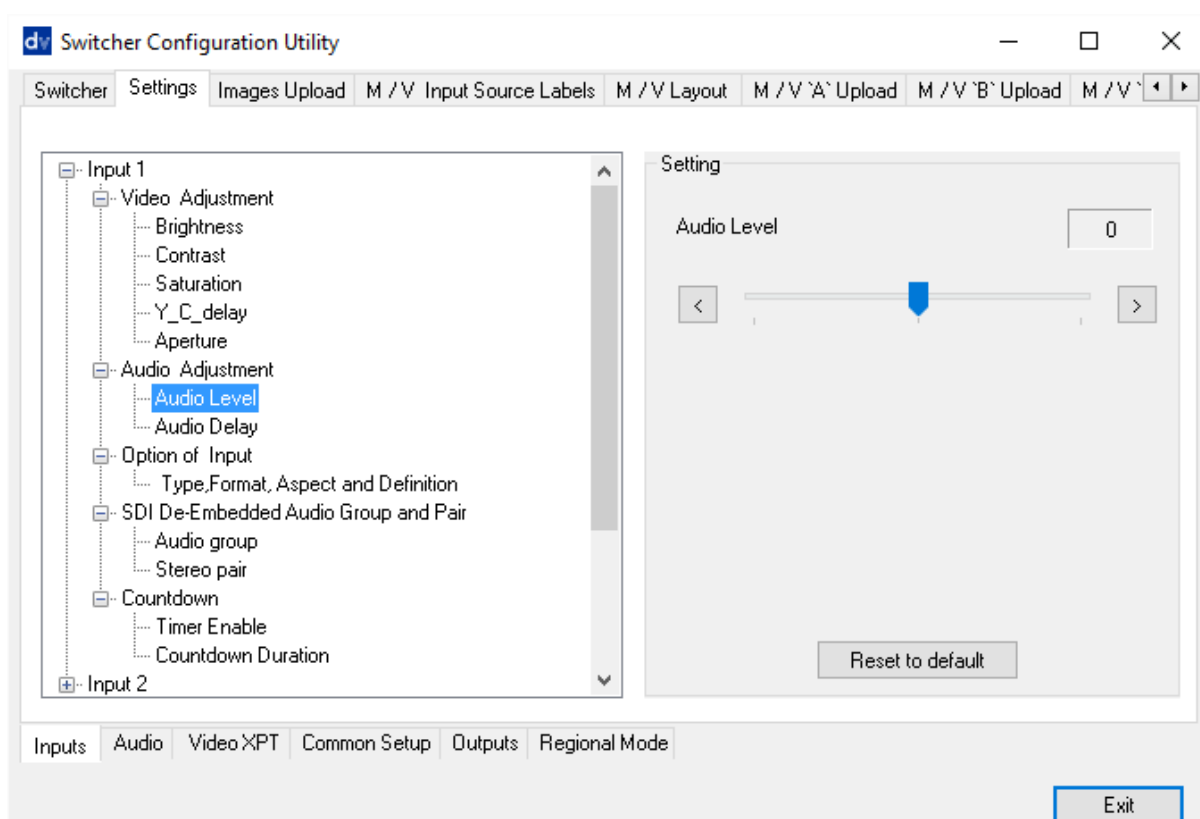

3.4.1 Inputs tab

The Input settings of inputs 1 to 12 can thus be configured from the computer. Clicking the Inputs tab will display a list of various input settings.

Note due to the design of the switcher, different inputs (SDI or HDMI) may have more or less options as they are not all the same. See [Rear Panel Connections](#).

Video Adjustment This is fine tune adjustment, the change occurs gradually as the value is increased or	Brightness	-56 - +56
	Contrast	-28 - +28
	Saturation	-28 - +28
	YC Delay	-4 - +3
	Aperture	0 - 3

decreased.		
Audio Adjustment This is fine tune adjustment, the change occurs gradually as the value is increased or decreased.	Audio Level	-60 - +60
	Audio Delay	0 - 17
Option of Input All HD inputs are natively 16:9 aspect ratio.	Type, Format, Aspect and Definition	SDI SD 4:3 SDI HD 1080i SDI SD 16:9 SDI HD 720p SDI 3G 1080p SDI HD 1080p
SDI De-Embedded Audio Group and Pair User choice of Group 1/2/3/4 and Pair 1/2	Audio Group	Audio group 1 / 2 / 3 / 4
	Stereo Pair	Stereo pair 1 / 2
Countdown Each input can be selected for Countdown ON or OFF. If Countdown is ON then the Down Counter value is set in minutes and seconds (MM:SS) – MAX. = 1 Hour or 60:00, and Default = 15 Seconds or 00:15.	Timer Enable	ON / OFF
	Countdown Duration	1 – 3600

Options in the table below will be available for HDMI inputs.

HDMI Color Mode User choice of HDMI Color Modes	RGB YUV 4:2:2 YUV 4:4:4	
HDMI De-Embedded Audio Pair User choice of Pair 1/2/3/4	HDMI Audio Pair	Stereo Pair 1 Stereo Pair 2 Stereo Pair 3 Stereo Pair 4

3.4.2 Audio Tab

The Audio settings of inputs 1 to 12 can be configured from the computer. Clicking the Audio tab will display a list of various audio settings as shown in the diagram below.

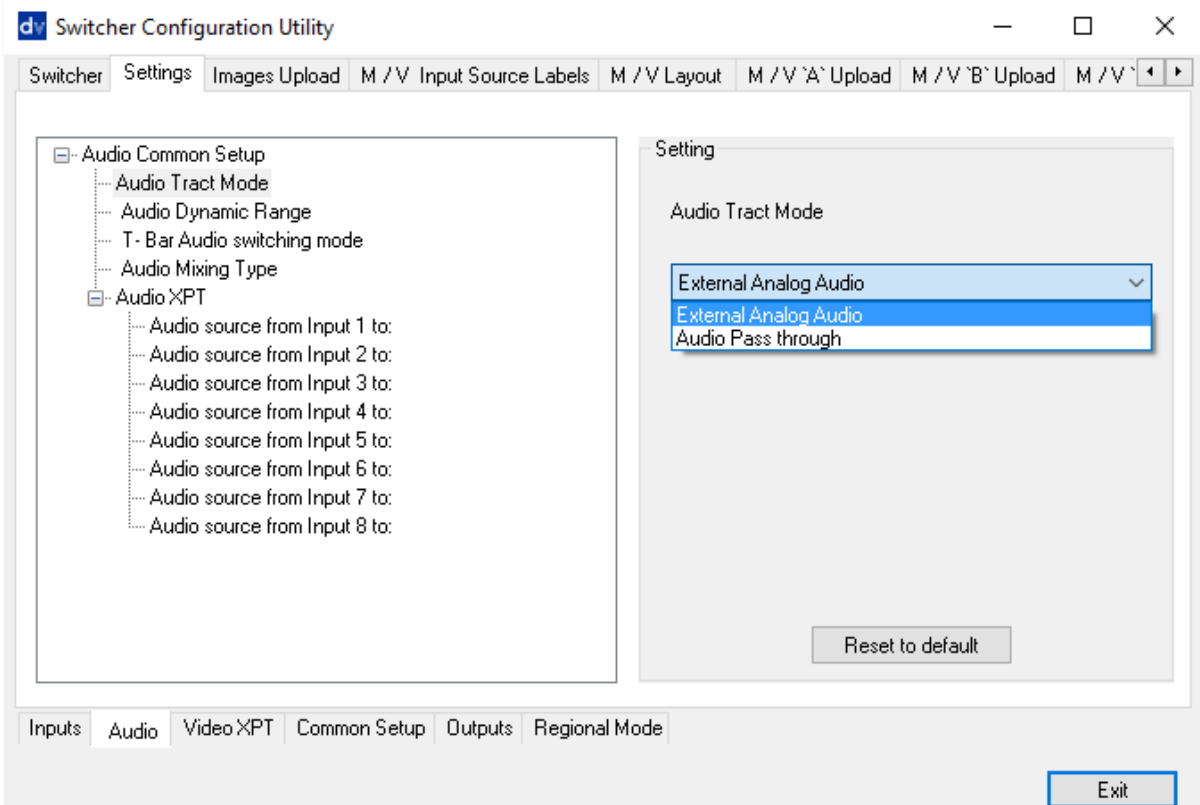

Audio Tract Mode	External Analog Audio	
	Audio Pass Through	
Audio Dynamic Range	-18 dBFS / -24dBFS	
T-Bar Audio Switching Mode	As selected Audio Mixing Type	User choice of Audio Mixing Type (X or V) or Clean Cut after the T-Bar reaches the Limit Switch.
	T-Bar reaches the Limit Switch	
Audio Mixing Type	Type V	User choice of X type (A/B cross fade), V type (Fade out A then Fade in B)
	Type X	
Audio XPT Any of input audio sources can be associated with any of input button (or buttons). Different video sources with the same audio.	Audio source from Input 1 to:	Audio source from Input 1 to: Button 1 Button 2 Button 3 Button 4 Button 5 Button 6 Button 7 Button 8
	Audio source from Input 2 to:	Audio source from Input 2 to: Button 1 Button 2 Button 3 Button 4 Button 5 Button 6 Button 7

	Button 8
Audio source from Input 3 to:	Audio source from Input 3 to: Button 1 Button 2 Button 3 Button 4 Button 5 Button 6 Button 7 Button 8
Audio source from Input 4 to:	Audio source from Input 4 to: Button 1 Button 2 Button 3 Button 4 Button 5 Button 6 Button 7 Button 8
Audio source from Input 5 to:	Audio source from Input 5 to: Button 1 Button 2 Button 3 Button 4 Button 5 Button 6 Button 7 Button 8
Audio source from Input 6 to:	Audio source from Input 6 to: Button 1 Button 2 Button 3 Button 4 Button 5 Button 6 Button 7 Button 8
Audio source from Input 7 to:	Audio source from Input 7 to: Button 1 Button 2 Button 3 Button 4 Button 5 Button 6 Button 7 Button 8
Audio source from Input 8 to:	Audio source from Input 8 to: Button 1 Button 2

		Button 3 Button 4 Button 5 Button 6 Button 7 Button 8
--	--	--

3.4.3 Video XPT Tab

The user can also set the Input Video Crosspoints from the computer. Clicking the Video XPT tab will display a list of configurable video inputs as shown in the diagram below.

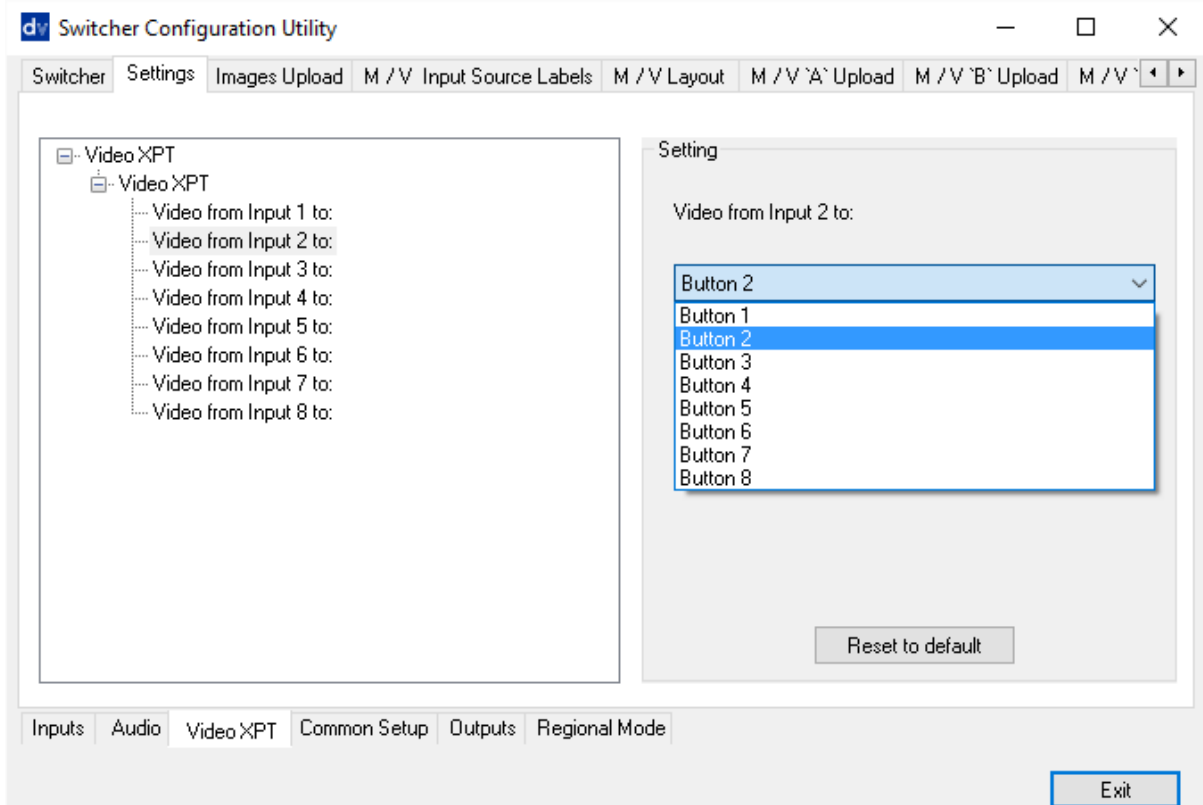

Video XPT Any of video sources can be associated with any of Console 1-8 buttons.	Video from Input 1 to:	Video from Input 1 to: Button 1 Button 2 Button 3 Button 4 Button 5 Button 6 Button 7 Button 8
	Video from Input 2 to:	Video from Input 2 to: Button 1 Button 2 Button 3 Button 4 Button 5 Button 6

		Button 7 Button 8
	Video from Input 3 to:	Video from Input 3 to: Button 1 Button 2 Button 3 Button 4 Button 5 Button 6 Button 7 Button 8
	Video from Input 4 to:	Video from Input 4 to: Button 1 Button 2 Button 3 Button 4 Button 5 Button 6 Button 7 Button 8
	Video from Input 5 to:	Video from Input 5 to: Button 1 Button 2 Button 3 Button 4 Button 5 Button 6 Button 7 Button 8
	Video from Input 6 to:	Video from Input 6 to: Button 1 Button 2 Button 3 Button 4 Button 5 Button 6 Button 7 Button 8
	Video from Input 7 to:	Video from Input 7 to: Button 1 Button 2 Button 3 Button 4 Button 5 Button 6 Button 7 Button 8
	Video from Input 8 to:	Video from Input 8 to: Button 1

		Button 2 Button 3 Button 4 Button 5 Button 6 Button 7 Button 8
--	--	--

Note: In the HS-2850, each input source must be associated with only one button. If you associate one source to more than one button, corrupted small windows will appear on the HS-2850 Multiview display. To avoid this please make sure your XPT setting is configured to one input to one button arrangement.

3.4.4 Common Setup

The **Common Setup** tab will allow you to set up various image effects such as the logo, DSK and PiP, as well as WIPE transition effects.

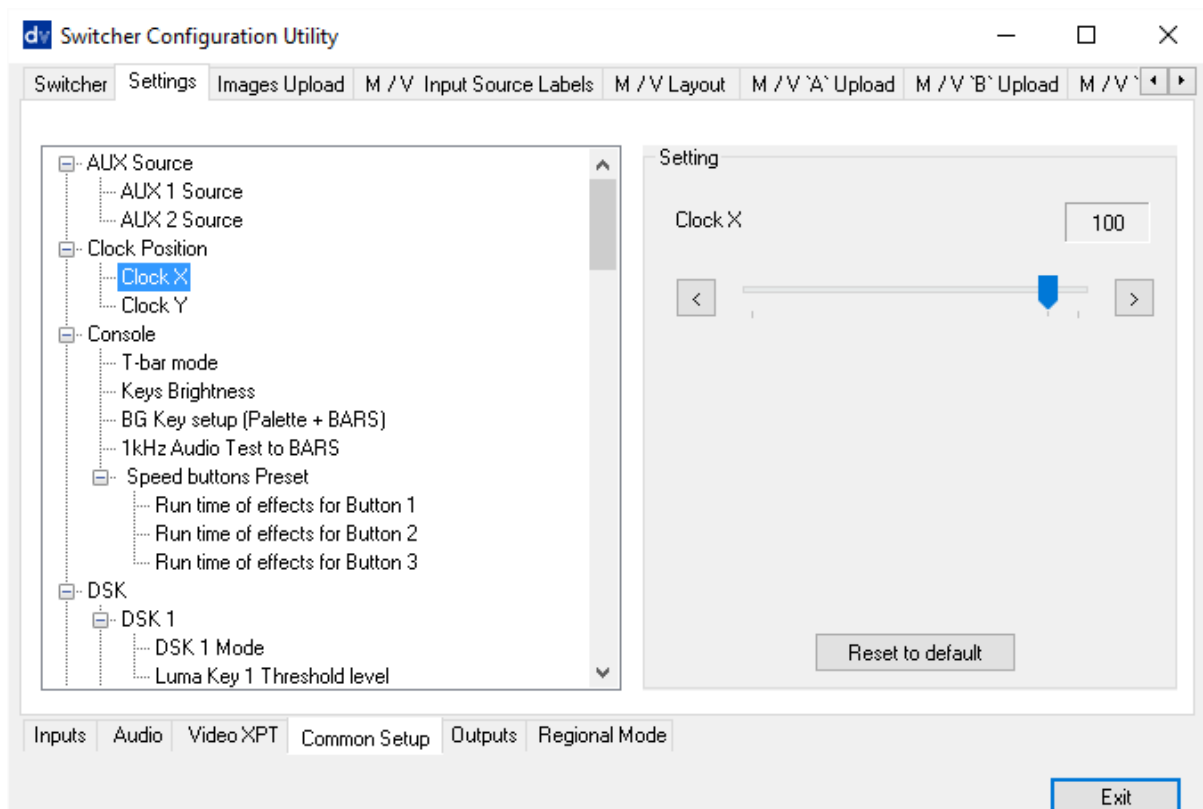

AUX Source	AUX 1 Source	1 – 12	
	AUX 2 Source	1 – 12	
Clock Position X-Position = Left to Right; Y-Position = Lower to Upper; Set Hours; Set Minutes; Clear Seconds	Clock X	0 – 110	
	Clock Y	124 – 0	
Console	T-Bar Mode	One Way	T-Bar operates transition in only one direction.

		Two Way	T-Bar operates transition in both directions.
	Keys Brightness	1 – 4	
	BG Key Setup (Palette + BARS)	Color 1	User choice of background color from 1 to 9. By default, color is 1. 1 = White; 2 = Yellow; 3 = Cyan; 4 = Green; 5 = Magenta; 6 = Red; 7 = Blue; 8 = Black; 9 = SMPTE 75% Color Bars. The color can be changed in the Palette setup.
		Color 2	
		Color 3	
		Color 4	
		Color 5	
		Color 6	
		Color 7	
		Color 8	
	BARS		
	1kHz Audio Test to BARS	1kHz to BARS is ON	When BG Color setting is 9 (BARS), 1kHz tone can be ON or OFF.
		1kHz to BARS is OFF	
	Speed Buttons Preset Run time of effects: Min. = 4 Frames (maximum speed); Max. = 64 Frames (minimum speed).	Run time of effects for Button 1	4-100
		Run time of effects for Button 2	4-100
		Run time of effects for Button 3	4-100
DSK HS-2850 has FILL and KEY model (alpha channel) and LUMA KEY mode 0 (black) to 255 (white).	DSK 1	DSK 1 Mode	Luma Key mode
			Fill and Key mode
	DSK 2	Luma Key 1 Threshold Level	0 – 255
		DSK 2 Mode	Luma Key mode
		Fill and Key mode	
		Luma Key 2 Threshold Level	0 – 255
External Clocking	Reference Enable	Checkbox	
	Reference Mode	CVBS PAL	
		3 Level Sync	
H-timing	0 – 255		
GPI	GPI Input	1 – 12	
	GPI Delay	0 – 75	
	GPI Mode	Level Mode	
Pulse Mode			
Logos	Logo 1	Logo 1 Picture	1 – 8

X Position = Left to Right; Y Position = Lower to Upper; Options 1 to 8. Logo options 1 to 7 are still images. Logo 8 is dynamic moving image.		Logo 1 X	0 – 110
		Logo 1 Y	124 – 5
	Logo 2 Logo options 1 to 7 are still images. Logo 8 is dynamic moving image.	Logo 2 Picture	1 – 8
		Logo 2 X	0 – 110
		Logo 2 Y	124 – 5
Palette Common palette for all colors used in Wipes / Border / Background / PiP Border. By default, 75% YCbCr Color Bar from White (Color 1) to Black (Color 8). Any Palette Color can be changed by user.	Get Color 1		
	Get Color 2		
	Get Color 3		
	Get Color 4		
	Get Color 5		
	Get Color 6		
	Get Color 7		
	Get Color 8		
PiP User choice of position, window size, border width, and border color from 1 to 9. By default the color is 1. 1 = White; 2 = Yellow; 3 = Cyan; 4 = Green; 5 = Magenta; 6 = Red; 7 = Blue; 8 = Black; 9 = SMPTE 75% Color Bars. The color can be changed in the Palette setup.	PiP 1	PiP X-Axis Position	0 – 97
		PiP Y-Axis Position	108 – 0
		Picture Size	33 – 1
		Border Width	0 – 5
		Border Color	1 – 8
	PiP 2	PiP X-Axis Position	0 – 97
		PiP Y-Axis Position	108 – 0
		Picture Size	33 – 1
		Border Width	0 – 5
		Border Color	1 – 8
	PiP Border Color Density	Color 1 Density	0 – 15
		Color 2 Density	0 – 15
		Color 3 Density	0 – 15
		Color 4 Density	0 – 15
		Color 5 Density	0 – 15
		Color 6 Density	0 – 15
Color 7 Density		0 – 15	
Color 8 Density	0 – 15		
WIPES User choice of Wipe 1 to 8; Soft Edge 0 to 4; Border Colour from 1 to 8. By default, color is 1. 1 = White; 2 = Yellow; 3 = Cyan; 4 = Green; 5 = Magenta; 6 = Red; 7 = Blue; 8 = Black; 9 = SMPTE 75% Color Bars.	WIPES 1	Effect	1 – 8
		Border Width	1 – 5
		Border Color	1 – 8
	WIPES 2	Effect	1 – 8
		Border Width	1 – 5
		Border Color	1 – 8
	WIPES 3	Effect	1 – 8
		Border Width	1 – 5
		Border Color	1 – 8
	WIPES 4	Effect	1 – 8
Border Width		1 – 5	

The color can be changed in the Palette setup.	WIPES 5	Border Color	1 – 8
		Effect	1 – 8
		Border Width	1 – 5
	WIPES 6	Border Color	1 – 8
		Effect	1 – 8
		Border Width	1 – 5
		Border Color	1 – 8

3.4.5 Outputs Tab

The Output settings of outputs 1 to 4 can also be configured from the computer. Clicking the **Outputs** tab will display a list of various input settings.

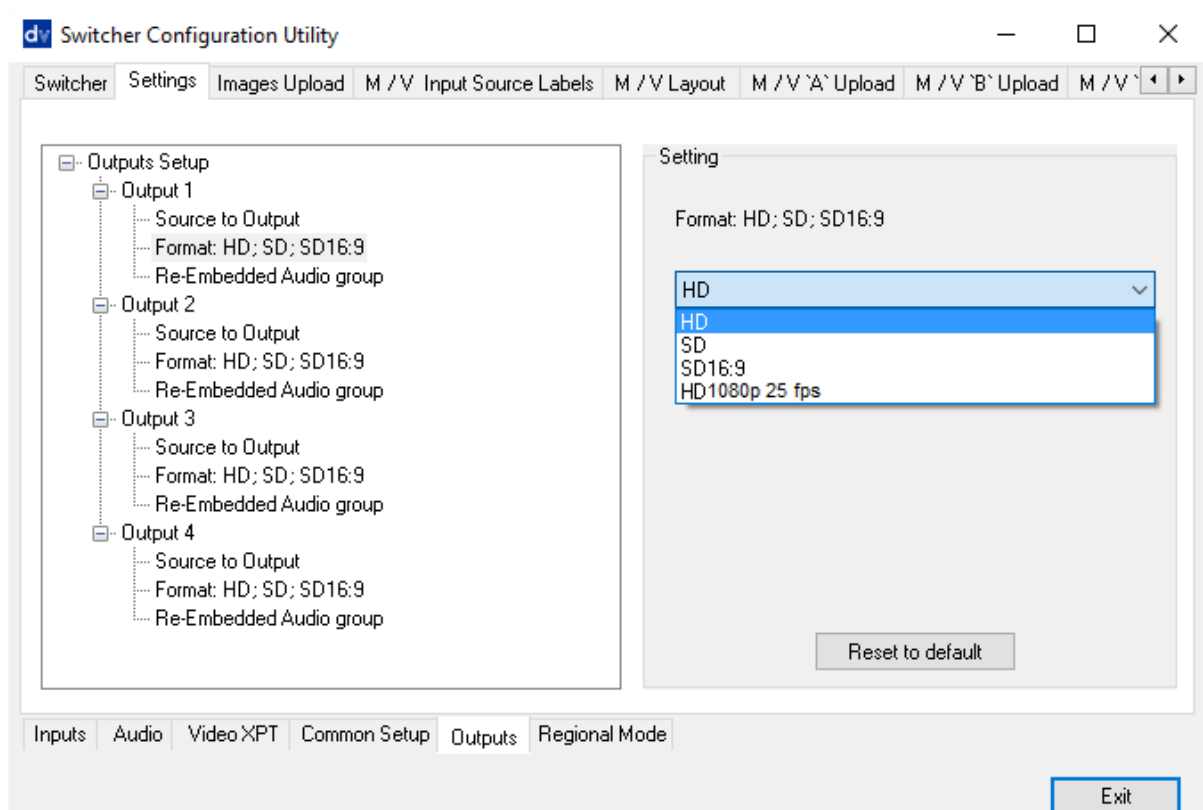

Output 1	Source to Output	Program
		Program Logo Free
		Program Logo and Titles Free
		Preview
		AUX 1
		AUX 2
	Format: HD; SD; SD 16:9	HD
	SD	
	SD 16:9	
	HD 1080p 25 fps	
	Re-Embedded Audio Group	1-4
Output 2	Source to Output	Program
		Program Logo Free
		Program Logo and Titles Free
		Preview

		AUX 1
		AUX 2
	Format: HD; SD; SD 16:9	HD
		SD
		SD 16:9
	HD 1080p 25 fps	
	Re-Embedded Audio Group	1-4
Output 3	Source to Output	Program
		Program Logo Free
		Program Logo and Titles Free
		Preview
		AUX 1
		AUX 2
	Format: HD; SD; SD 16:9	HD
		SD
		SD 16:9
		HD 1080p 25 fps
	Re-Embedded Audio Group	1-4
Output 4	Source to Output	Program
		Program Logo Free
		Program Logo and Titles Free
		Preview
		AUX 1
		AUX 2
	Format: HD; SD; SD 16:9	HD
		SD
		SD 16:9
		HD 1080p 25 fps
	Re-Embedded Audio Group	1-4

3.5 Images Upload tab

3.5.1 Still Pictures

Each switcher has the ability to store still pictures in its frame stores. If the switcher has eight inputs it has the ability to store eight still pictures. Twelve pictures can be stored if the unit has twelve inputs. See **FS button** in [Section 2.2.5](#) also.

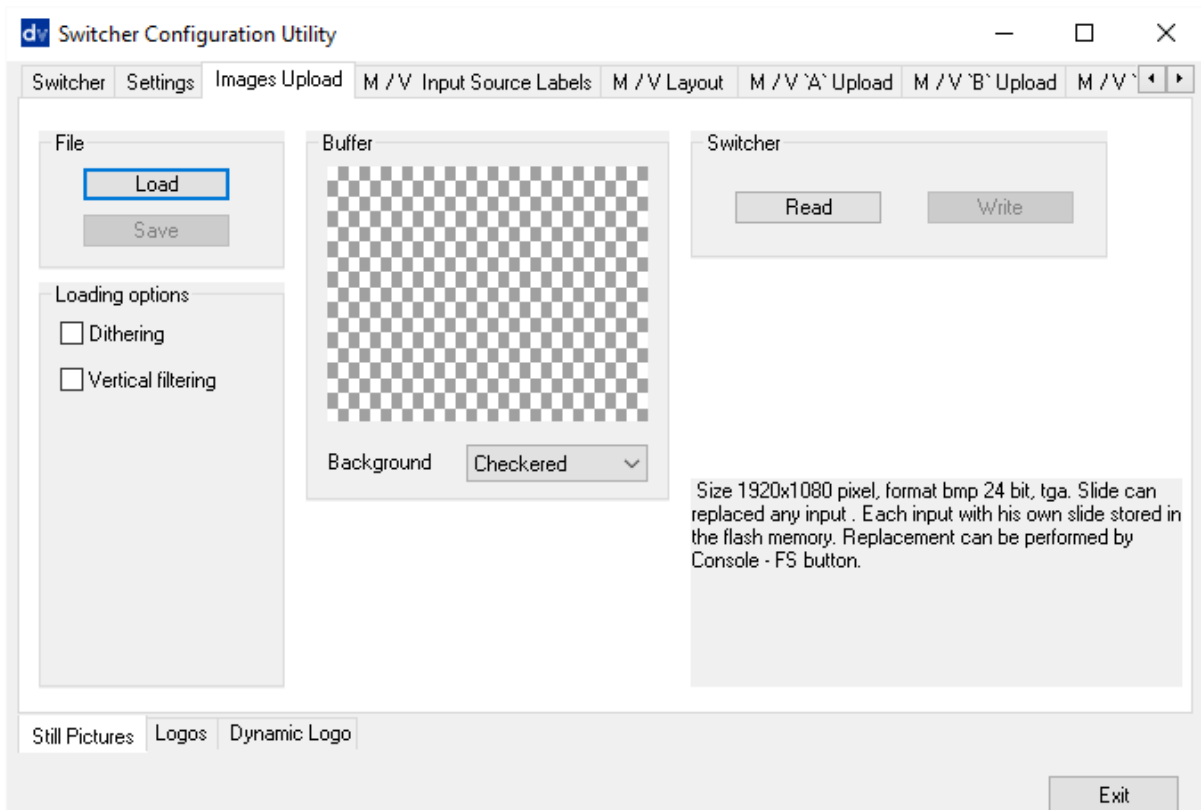

The **LOAD** button can be used to browse for a picture stored on the computer. This picture is then loaded into the application window. Loading options must be selected before loading.

The **WRITE** button can then be used to save the new picture into a selected frame store on the switcher.

3.5.2 Logos

The HS-2850 can store up to eight still logos in its memory.

Using the logos tab you can use the **LOAD** button to browse for a logo stored on the computer. This logo is then loaded into the application window.

The **WRITE** button can then be used to save the new logo into a selected logo store on the switcher.

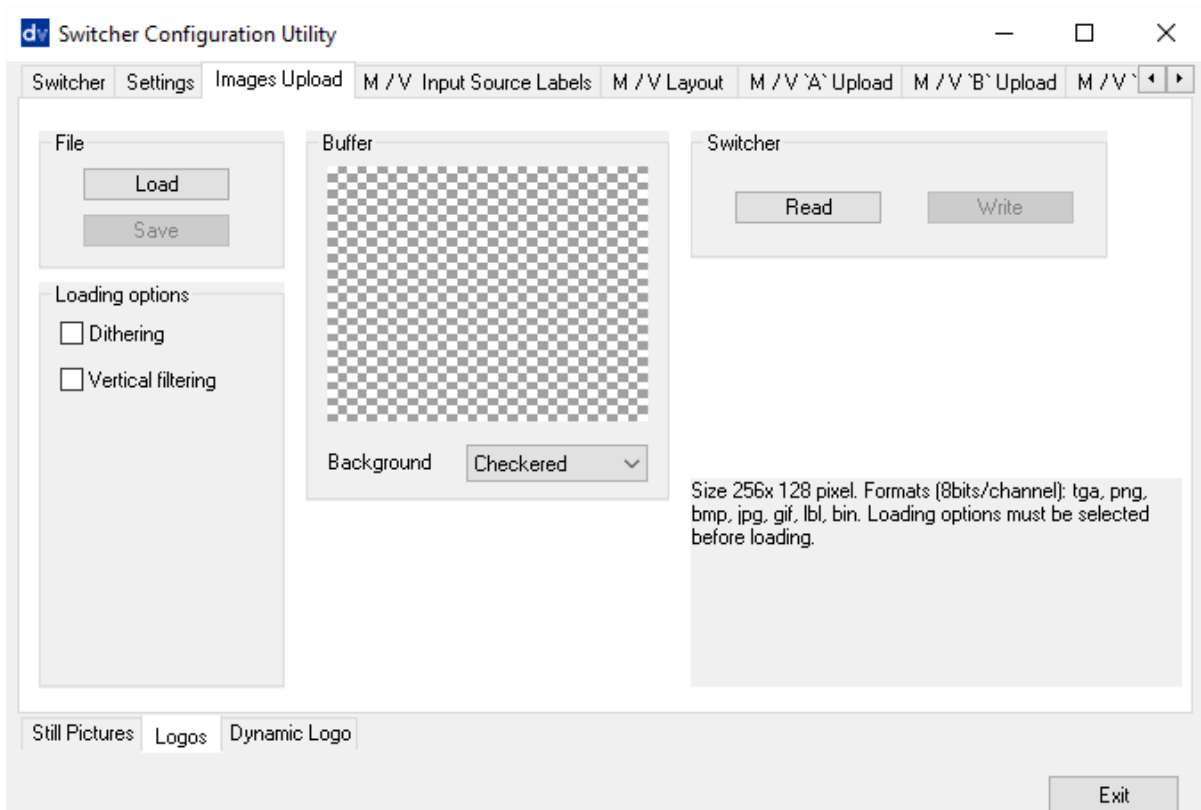

3.5.3 Dynamic Logo

The HS-2850 can store one dynamic moving logo in its memory. The dynamic logo can be a targa (TGA), png, bmp or jpg sequence, GIF or AVI. It must be no longer than 75 frames/images long.

Using the Dynamic logo tab you can use the **LOAD** button to browse for a logo sequence of images stored on the computer. This logo sequence is then loaded into the application window. The sequence is indicated by the number in the title (two digits: 01, 02 and etc). Click the **EDIT** button to import the source file to the built-in editor, which converts the file to the dlb format for saving on the device.

The **WRITE** button can then be used to save the new logo sequence into the dynamic logo store on the switcher.

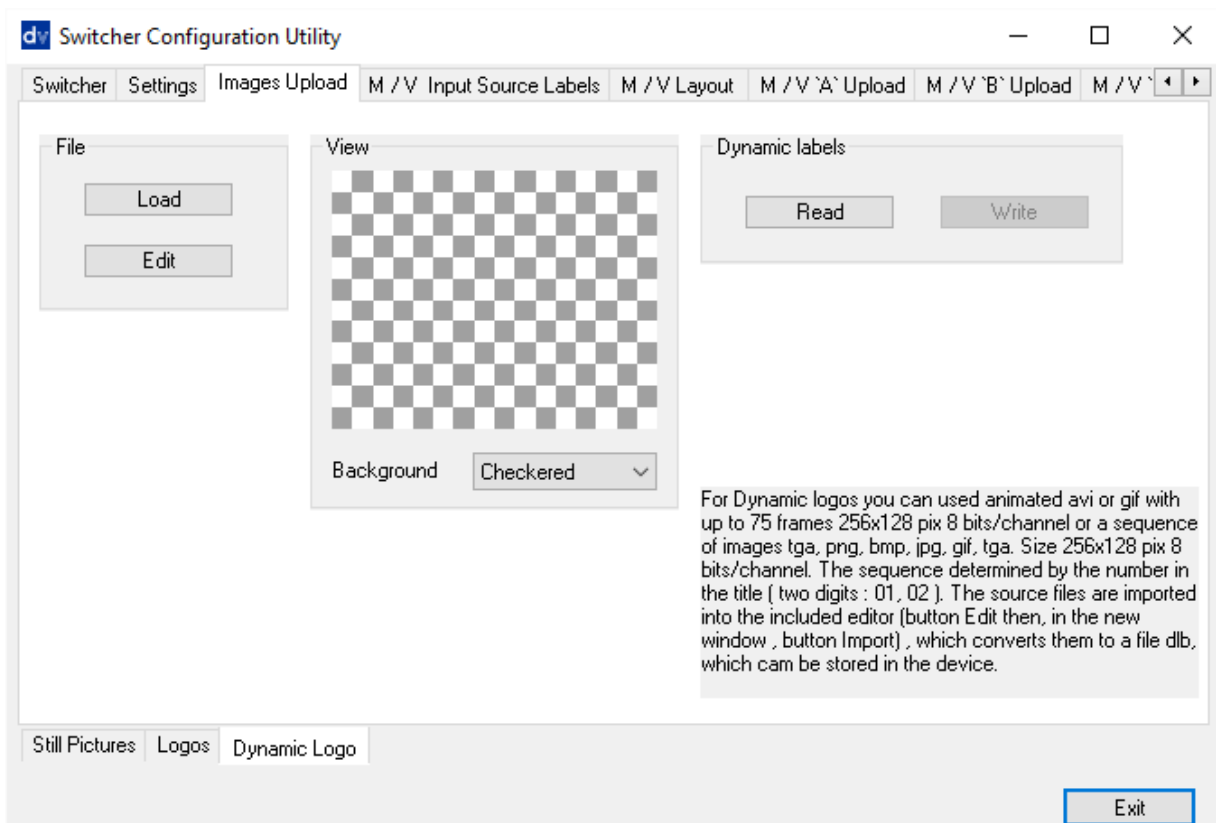

3.6 Multi screen window signs (labels) tab

This tab allows the user to rename the input source labels on the HDMI multi view.

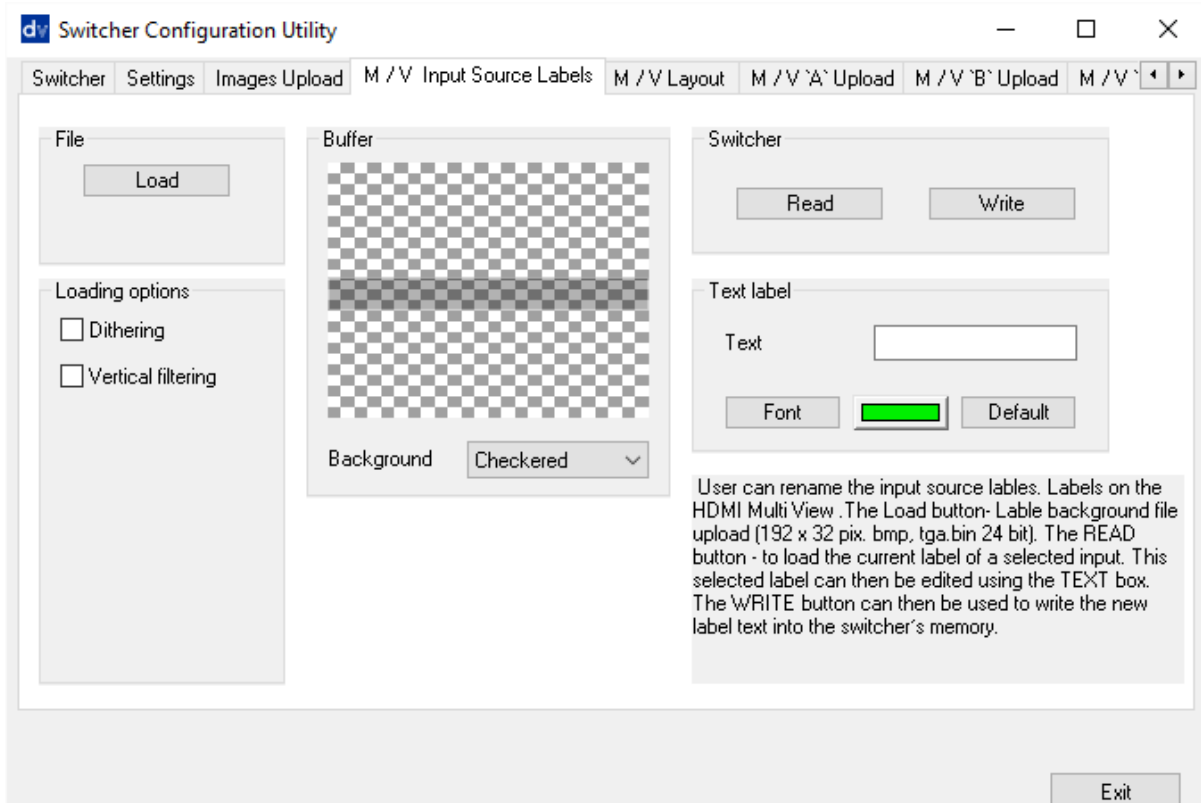

The **READ** button can be used to load the current label of a selected input into the application window on the left. This selected label can then be edited using the **TEXT** box. If required the font and colour of the text can also be changed.

The **WRITE** button can then be used to write the new label text into the switcher’s memory.

3.7 Multiview Layout Tab

The Multiview Layout Tab allows you to set the Multiview Layout displayed on the two HDMI outputs.

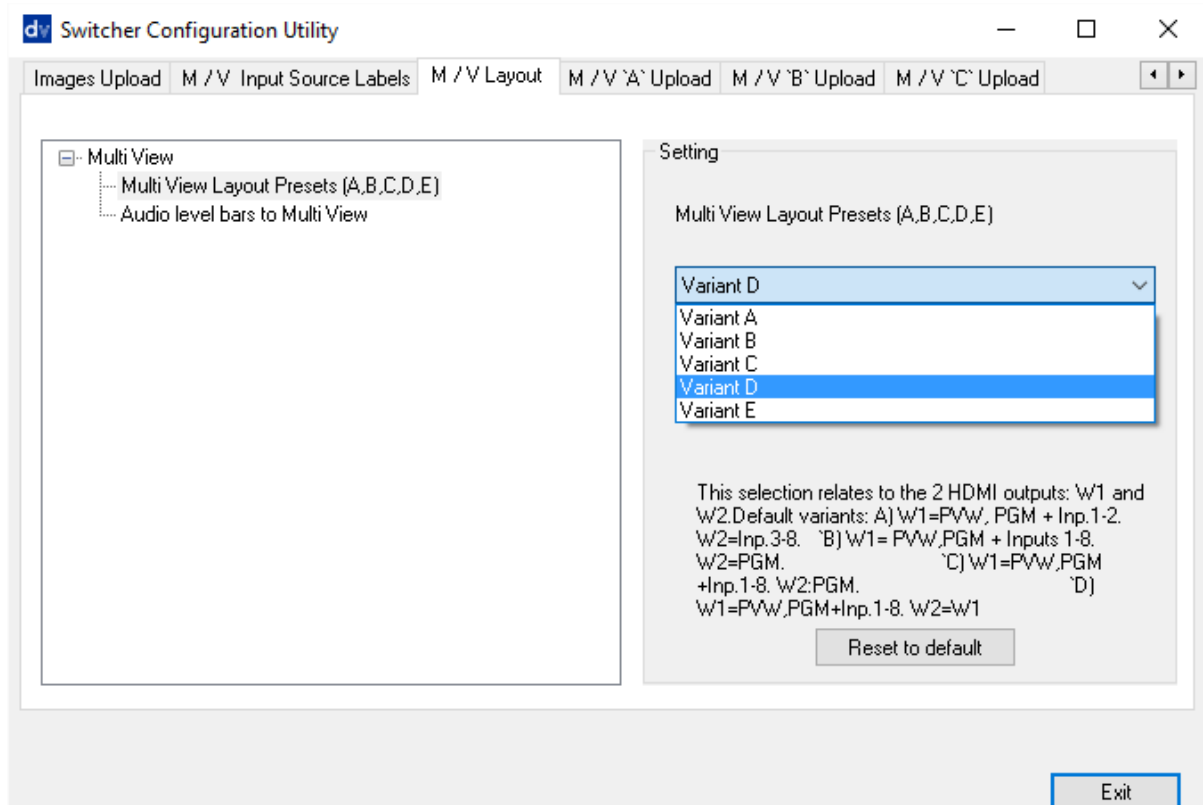

There are five variants listed as follows:

- A** W1 = PVW / PGM / Inputs 1-2
W2 = Inputs 3-8
- B** W1 = PVW / PGM / Inputs 1-8
W2 = PGM
- C** W1 = PVW / PGM / Inputs 1-8
W2 = PGM
- D** W1 = PVW / PGM / Inputs 1-8
W2 = W1
- E** W1 = PVW / PGM / Inputs 1-8
W2 = W1

The “**Audio level bars to Multi View**” option allows you to enable / disable the audio level bars on the Multiview window.

3.8 Multiview Upload Tabs (A / B / C)

These three tabs are used to write new Multiscreen layouts to the switcher in order to change the HDMI multi-view layouts as described in the **HDMI Multi-View** section.

The user can change Multiview layout. Simply clicking the “**LOAD**” button to browse for a Multiview files (file extension *.mss) stored on the computer. This file is then loaded into the application window. The **WRITE** button can be used to set the new Multiview layout.

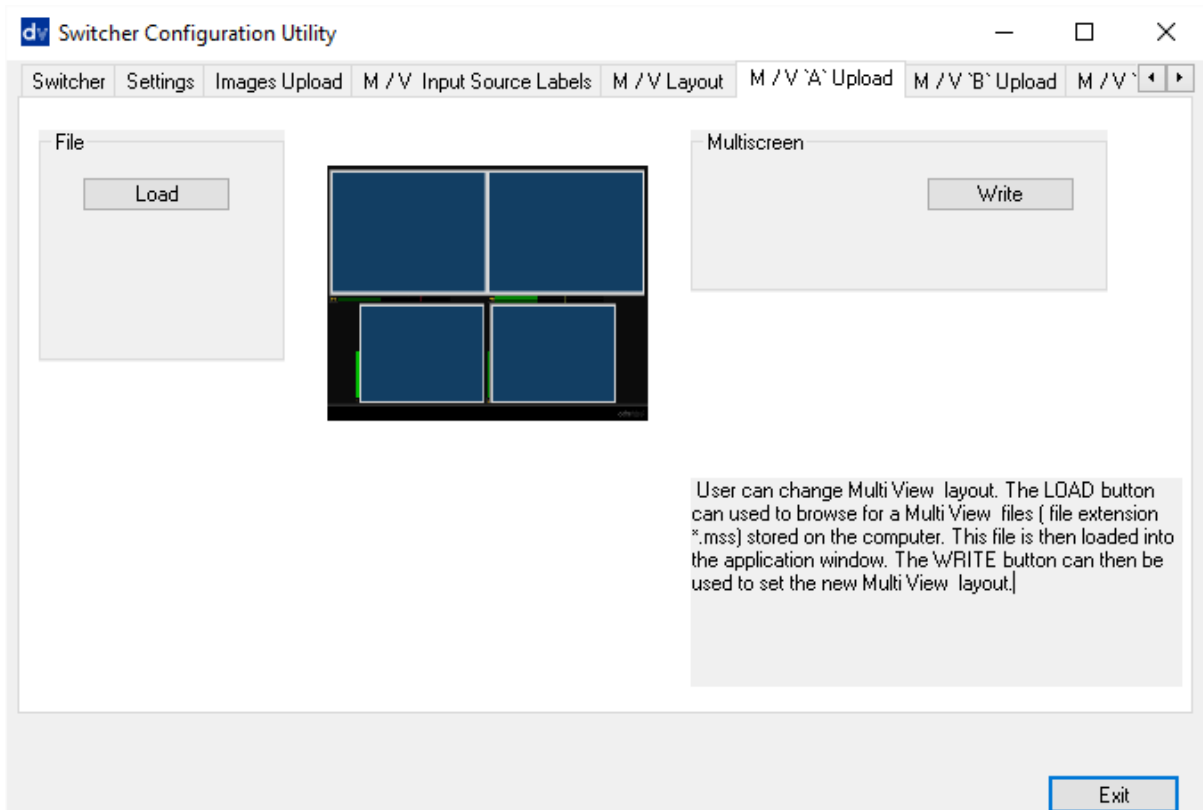

NOTE: Only change these layouts with guidance from your local Datavideo office as attempting to edit or load your own layouts may result in a poor outcome or a non-responsive switcher.

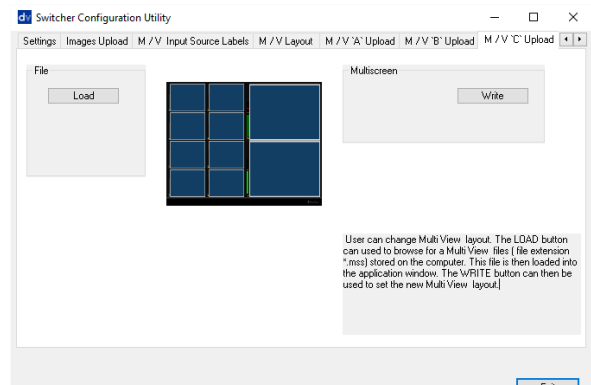
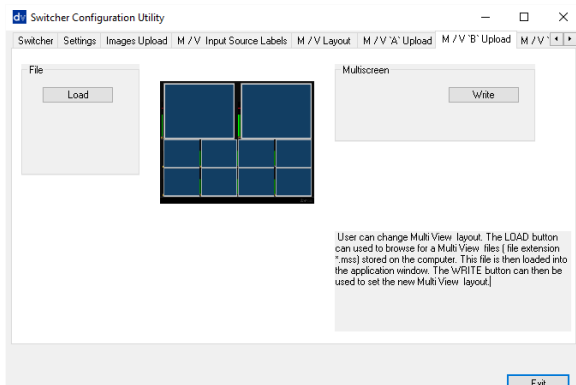

Chapter 4 Switcher Video

4.1 HDMI Multi-View

HS-2850 Multi-view monitoring is available across one or two HDMI monitors (not supplied). These HDMI outputs can be used to monitor video and audio in a number of different configurations. For each setup, embedded audio level indication is also available on all inputs as well as the Preview and Program windows.

This Multi-view is supplied from the HDMI connection(s) on the rear panel. (See **Rear Panel**, item 16.) When connected to two compatible HDMI monitors, a variety of multi-image layouts is possible.

Configuration A:

- On HDMI screen 1: 9 live inputs
- On HDMI screen 2: 3 live inputs with additional Preview and Program windows

Configuration B:

- On HDMI screen 1: 12 live inputs with additional Preview and Program windows
- On HDMI screen 2: Program window

Configuration C:

- On HDMI screen 1: 8 live inputs with additional Preview and Program windows
- On HDMI screen 2: Program window

Configuration D:

- On HDMI screen 1: 12 live inputs with additional Preview and Program windows
- On HDMI screen 2: Same as HDMI screen 1

Configuration E:

- On HDMI screen 1: 8 live inputs with additional Preview and Program windows
- On HDMI screen 2: Same as HDMI screen 1

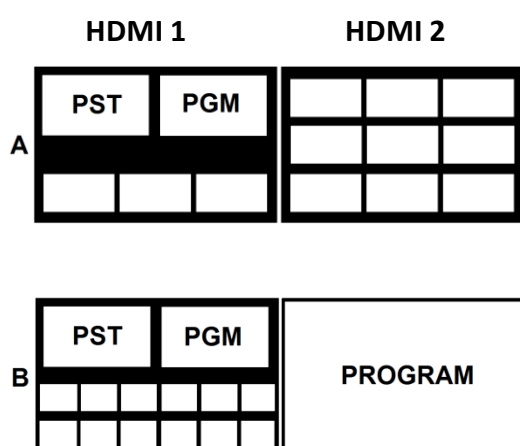

Shown left are the five multi-view configuration options A to E.

How to change the Multi-view output

To change the multi-view option on your switcher press the **ENTER** button in the **MENU area** of the HS-2850 Control Panel / Keyboard. This will display an on screen menu on HDMI output 1. Then use the arrow down button to highlight the option **Multi Screen Mode**. Use the arrow keys to highlight your preferred option from those shown on the left. Use the arrow keys to place a tick in the selection box and then press **ENTER** to save this choice.

On screen Tally indication

The HS-2850 Multi-Image Preview supplies

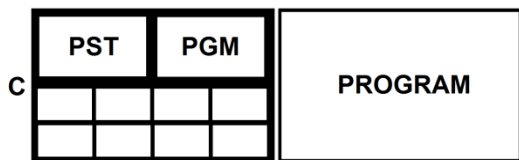

basic tally information by highlighting the live Program input source with a red border, and the cued next input source with a yellow border.

Function Area

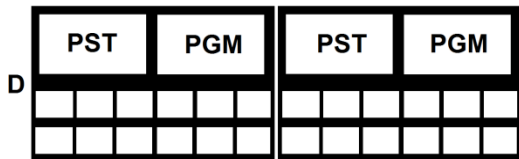

Below the Program and Preset image windows is a function area occupied by a real time Clock, Countdown Timer (if active), chosen Wipe indicator, PC or Console control indication and chosen Audio mix and Audio level indicators.

Labels

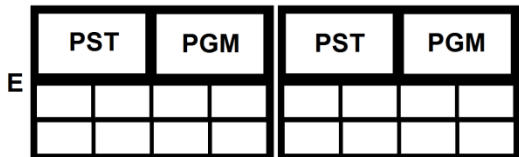

Below each video input channel window there is a label. These labels can be edited using the software supplied with the HS-2850, see [Chapter 3](#) for more details.

4.2 Video Layers

The HS-2850 is a Standard Definition or High Definition Digital Video Switcher and as well as mixing video and audio sources it has additional functions such as Picture In Picture (PIP), DSK LUMA KEY and LOGOs.

Before attempting to use the HS-2850's PIP, DSK LUMA KEY and LOGO functions it may help to first understand the order of the video layers at the HS-2850 Program (PGM) outputs.

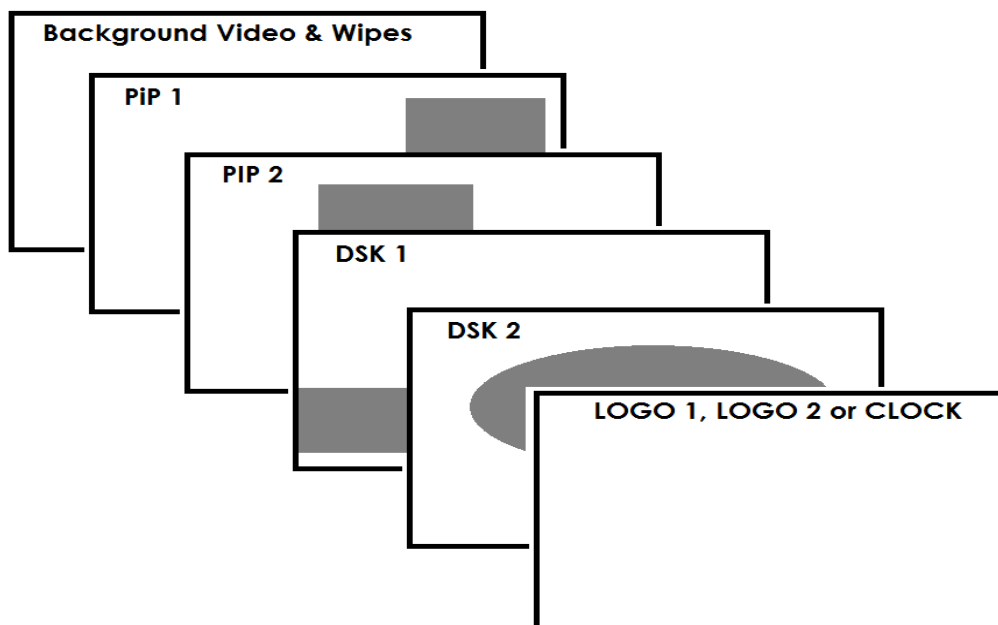

The **Background video layer** is the normal video layer when mixing and switching with the HS-2850. It occupies the whole screen area of the Program output. This layer can be hidden or partly hidden by the PIP, DSK and LOGO layers in front of it.

The **PIP 1 layer** does not occupy the whole screen and is shown in front of the Background video layer when enabled. In some setups the PIP 1 image can be hidden behind the PIP 2 image. This is not a fault. Change the position or size of the PIP 1 or PIP 2 image if required.

The **PIP 2 layer** does not occupy the whole screen and is shown in front of the Background video and PIP 1 layers when enabled. In some setups the PIP 1 image can hide the PIP 2 image. Change the position or size of the PIP 2 or PIP 1 image if required.

The **DSK 1 layer** can occupy the whole screen. If set up incorrectly this layer can stop the video layers behind it from being seen properly. Re-adjust your DSK 1 settings or switch off the DSK1 function on the HS-2850 to restore the video behind it.

The **DSK 2 layer** can occupy the whole screen. If set up incorrectly this layer can stop the video layers behind it from being seen properly. Re-adjust your DSK 2 settings or switch off the DSK2 function on the HS-2850 to restore the video behind it.

The **LOGO and Clock layer** does not occupy the whole screen and all other layers are visible through it. A logo if positioned incorrectly can partially hide an important part of the video, PIP or CG LUMA KEY layers. Typically logos or station ID bugs are placed in a corner of the screen.

Note: Where possible prepare and position the upper video layer elements in advance of the live production starting to avoid them appearing on the program output incorrectly.

Most broadcast networks have guidelines and advice on the use of video, images, music, logos and on screen text so it is best to check beforehand when planning a production. Do not use copyright protected content until you have the relevant permissions. Information on royalty free video, images and music is widely available, speak to your local dealer or search for advice on the internet.

Chapter 5 Audio Function

5.1 Overview

The HS-2850 has a simple, cost effective, **audio switcher** built in. This allows the HS-2850 to take audio from several sources either XLR analogue, SDI and/or HDMI inputs. This audio can be embedded onto the HDMI and SDI outputs and/or fed to the analogue XLR audio output connections.

You may de-embed audio from selected SDI or HDMI inputs and then connect this audio from the XLR outputs of the switcher to a separate external Audio Mixer, such as the Datavideo AM-100. Other audio sources such as microphones and background music can then be added at the AM-100.

Once the audio has been mixed externally in the AM-100 with any microphones or music sources it can then be fed back into the HS-2850 on the analogue XLR inputs. The HS-2850 can then embed this externally mixed audio on to the Program SDI and HDMI outputs.

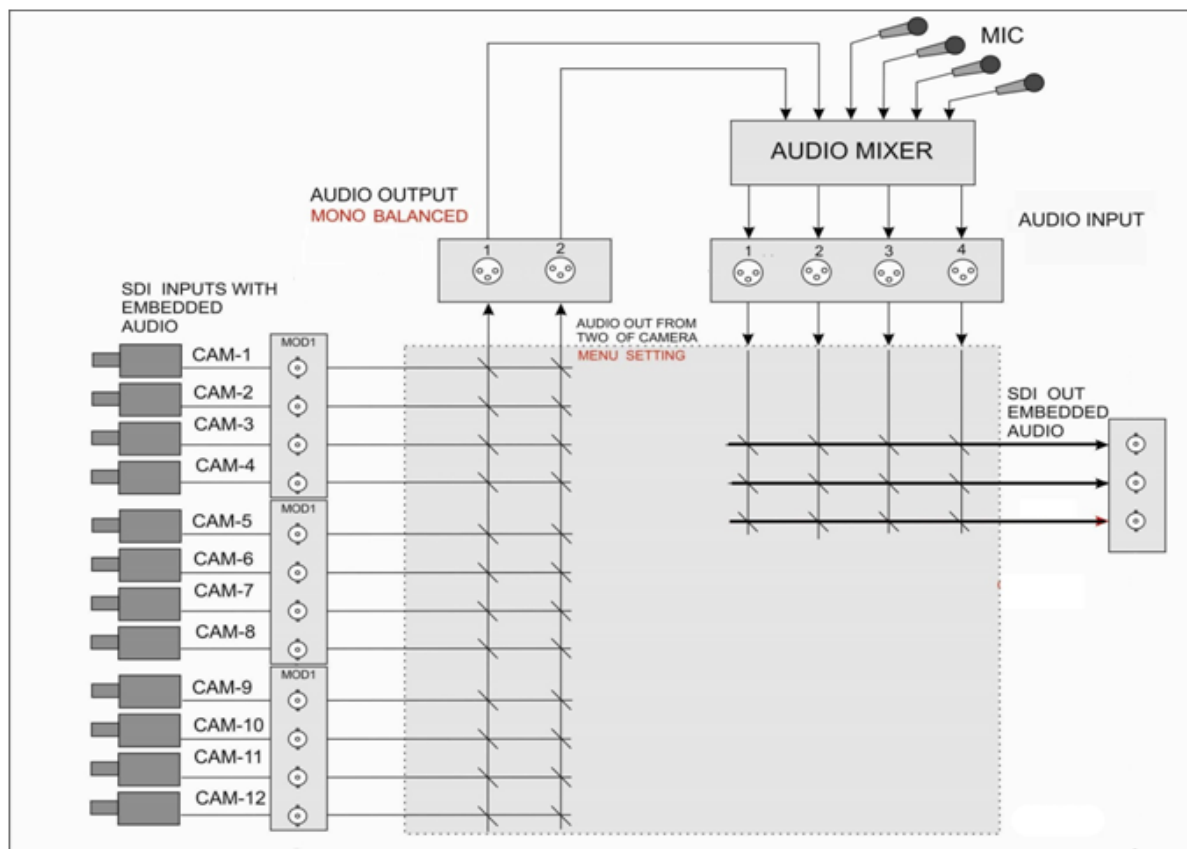

5.2 Audio Menu Options – De-embedding SDI or HDMI audio

Using the following HS-2850 menu options, audio can be selected from the SDI or HDMI video inputs.

SDI Embedded Audio Set.	Inputs 1 to 12	User choice of	Group 1,2,3 or 4 Pair 1 or 2
HDMI in Embedded Audio Pair	Input 4, 8 or 12	User choice of	Group 1,2,3 or 4

As each SDI / HD-SDI source can have up to sixteen channels of audio, and HDMI eight channels, we need to choose the audio channels with the options above and by using the following reference tables.

SDI Embedded Audio			
Group	Stereo Pair	Channel	Embedded Channel No.
Group 1	Stereo pair 1	left	1
		right	2
	Stereo pair 2	left	3
		right	4
Group 2	Stereo pair 3	left	5
		right	6
	Stereo pair 4	left	7
		right	8
Group 3	Stereo pair 5	left	9
		right	10
	Stereo pair 6	left	11
		right	12
Group 4	Stereo pair 7	left	13
		right	14
	Stereo pair 8	left	15
		right	16

HDMI Embedded Audio		
Stereo Pair	Channel	Embedded Channel No.
Stereo pair 1	left	1
	right	2
Stereo pair 2	left	3
	right	4
Stereo pair 3	left	5
	right	6
Stereo pair 4	left	7
	right	8

In some cases there may only be two channels of audio associated with the video: Group1, Stereo Pair 1.

An external audio mixer is not required. If you just want to work with SDI / HDMI embedded audio, it is necessary to physically connect the switcher's XLR outputs with the XLR inputs 1 and 2 to re-embed the audio again.

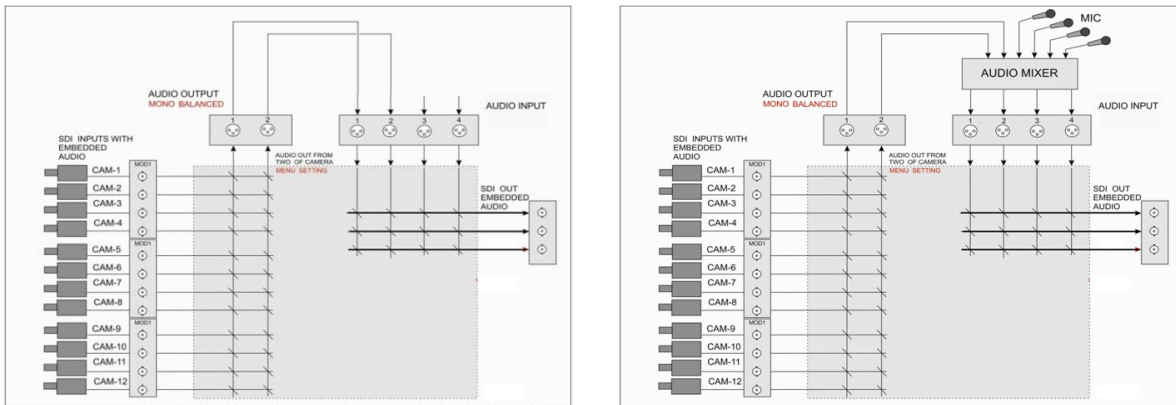

5.3 Audio Menu Options – Monitoring the audio levels

The HS-2850 can confirm the incoming audio levels by showing audio peak meters on the HDMI multi-view.

Audio level bars to Multi View	Tick selection ON or OFF
---------------------------------------	--------------------------

It is also possible to hear the preview or program audio from the multi-view HDMI outputs using the menu option below.

Multi Screen Audio Indicators	Tick selection of Program or Preview audio on the HDMI outputs.
--------------------------------------	---

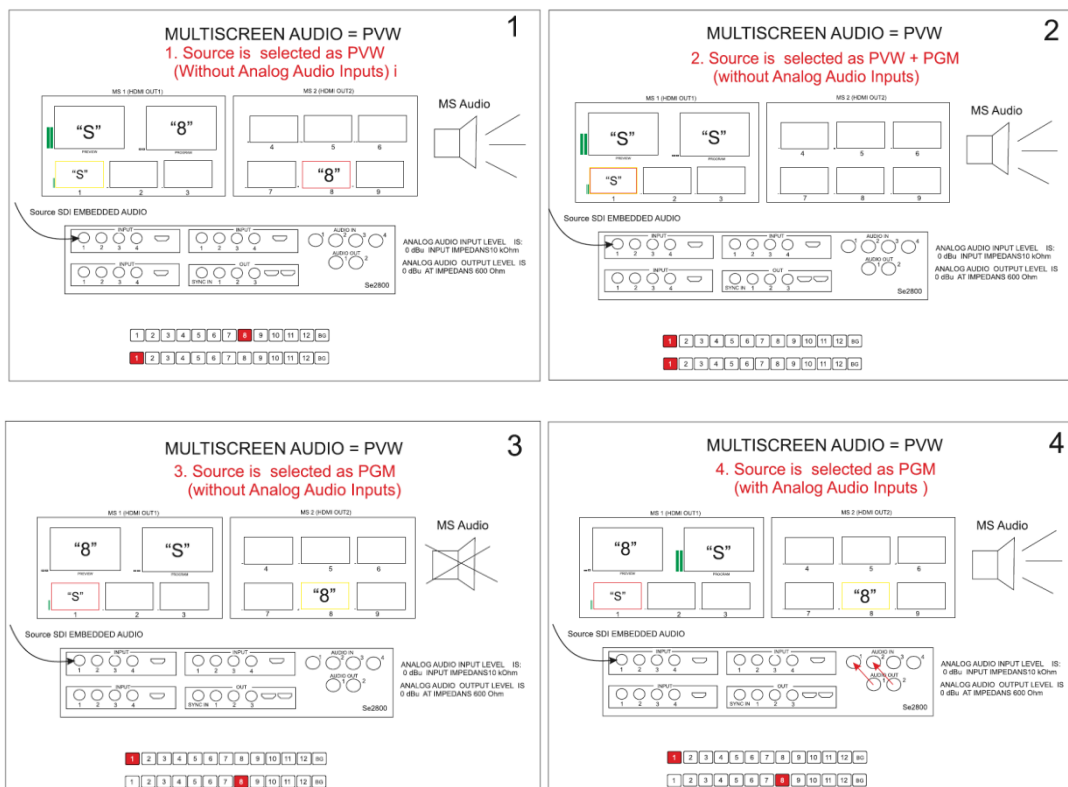

5.4 Audio Menu Options – Changing the audio input level

The HS-2850 can change the incoming audio level on the video inputs by adjusting the following menu option.

Input Audio Settings	Level	Range -60 to +60
	Nominal	Resets value to zero

The audio level can also be changed at the external audio mixer if one is used.

5.5 Working with a fixed or single audio source

Example 1:

We have two mono mics (channels 1 & 2) connected to a HD camera. These embedded audio channels are then output from this camera, HD-SDI, to the HS-2850 switcher. If we want to only hear these two audio channels regardless of the video channel used then we would set up the switcher in the following way.

Open the Switcher Configuration Utility, click Settings Tab → Audio Tab and then click '+' to expand the Audio XPT option. On the right pane of the window, set every input audio source to 1. Press the **EXIT** button to exit and save the audio settings.



After the new settings are saved, press the FIX/A+V button (**WIPE** area) to toggle between Audio Fixed and Audio-Follow-Video modes. Confirm that the **AUDIO FIXED** status has been selected by checking the status area of the HDMI multi-view. The status area is located just below or near the Preview image on the HDMI multi-view monitor. **The button will be backlit red.**

5.6 Switching between different embedded audio sources

Example 2:

We have two mono mics each connected to a different HD camera. The embedded audio is then output from each camera, HD-SDI, to the HS-2850 switcher. If we want to hear the audio from each camera as the video channels are switched, **audio follows video**, then we would set up in the following way.

Open the Switcher Configuration Utility, click Settings Tab → Audio Tab and then click '+' to expand the Audio XPT option. On the right pane of the window, set input 1 audio source to 1, input 2 audio source to 2, input 3 audio source to 3 and etc. Press the **EXIT** button to exit and save the audio settings.



After the new audio settings have been saved successfully, select the **AUDIO-F-VIDEO** status with this button. Confirm the **Audio-F-Video** status by checking the status area of the HDMI multi-view. The status area is located just below or near the Preview image on the HDMI multi-view monitor. The button will be off.

While working in the Audio-F-Video mode, the audio sources will also change as the video sources are switched. We can choose how the audio will change sources, whether it be a clean cut (immediate switch) or some sort of transitioned change (cross fade or fade out & in). To do this we would need to set up with the following menu options.

Auto Audio Mixing Type	Tick selection of	X type	X type = A/B cross fade
		V type	V type = Fade out A then fade in B
T-Bar Audio Mixing Type	Tick selection of	Follow auto audio mixing type (use above option)	
		By the end (clean cut or immediate audio switch)	

5.7 Audio Delay

The HS-2850 switcher has a feature for Audio Delay up to 16 fields, or 8 frames. The audio delay is expressed in fields with a default setting of '02' (2 fields / 1 frame) on each input until you change it.

Setting the Audio Delay

1. Power on HS-2850 Unit.
2. On the Preview bus, select the input that you would like to set Audio Delay.
3. Press any arrow key under the designated Menu row.
4. Press the Down Arrow [▼] key until "Input Audio Settings" is selected.
5. Press the Right Arrow [▶] key to enter into the Input Audio Settings Menu.
6. Press the Right Arrow [▶] key to enter the Audio Delay Setting Menu.
The default setting is 02; which is measured in fields. 2 fields = 1 frame.
7. Use the Arrow keys to set the number of fields, or frames. You can set the delay from 1 to 16 fields, which is the equivalent of 1 to 8 frames.
8. When you have made your selection, press the Enter key
9. To Exit the Menu, press any key in the Program or Preview Bus.

* To set audio delay for all inputs: repeat the above steps for each individual input. Otherwise, the Audio Delay will remain at the default setting of 02.

Chapter 6 Applications

6.1 Picture-In-Picture Function

The HS-2850 Picture in Picture function allows you to place one or two smaller PIP images over a chosen full size background image. The smaller PIP images can be set to pre-defined sizes and positioned almost anywhere within the Preview/Program screen area. These PIP windows can also have a coloured border applied, and can be brought into the production with a default PIP dissolve transition.

PIP Settings

Before trying to activate the PIP function it is best to understand how to set up or choose the right options for your production.



PIP Preset and PIP Program

When looking at the top right corner of the HS-2850 Control Panel / Keyboard there are four PIP keys. These are labelled Program and Preset.



The upper **PIP1** and **PIP2** keys relate to activating Picture In Picture images on the Program outputs.

The lower **PIP1** and **PIP2** keys relate to activating Picture In Picture images on the Multi-view or Preview outputs.

Assigning a video source input to a PIP

Using the lower **PIP1** or **PIP2** buttons, you can assign a selected video input to the chosen PIP video layer.

1. First press and hold down the required PIP button on the lower row. The Preset row of input sources will light.
2. While still holding down the PIP button, press to select the required input from the Preset row.
3. The input will flash to confirm it is selected.

This selection will also be confirmed on the HDMI Multi-view, with a P1 or P2 label shown next to the selected input image.

After successfully setting the PIP source, press the **ENTER Key** in the **MENU** area of the HS-2850 keyboard. Navigate to the **PIP Set Up** option using the down arrow key. The PIP menu options provided here are:

PIP Settings	Position PIP1	X-Position (Left to right) = 000 to 097
		Y-Position (Lower to Upper) = 000 to 108
	Size PIP1	PIP Size = 1 (small) to 33 (large)
	Border PIP1	Border Size = 0 (OFF), 1 (Thin) to 15 (Thick)
	Position PIP2	Border Color = 1 to 8 (user defined colours)
		1=Yellow, 2=Cyan, 3=Green, 4=Magenta, 5=Red, 6=Blue
	Size PIP2	
	Border PIP2	

6.2 Down Stream Keyer

The HS-2850 has two Down Stream Keyers (**DSK1**, **DSK2**). This means it is able to take a key source video input and replace the white or black parts of this image with the video from another source. If the input video carries an alpha channel it is also possible to key in this way too.

DSK Settings

Before trying to activate the DSK function it is best to understand how to set up or choose the right options for your production well in advance of the production.



DSK Preset and DSK Program

When looking at the top right corner of the HS-2850 Control Panel / Keyboard there are four **DSK** keys. These are labelled Program and Preset.



The upper **DSK1** and **DSK2** keys relate to activating Down Stream Keying on the Program outputs.

The lower **DSK1** and **DSK2** keys relate to activating Down Stream Keying on the Multi-view or Preview outputs.

Assigning an input to a DSK channel for keying

Using the lower **DSK1** or **DSK2** buttons, you can assign a selected video input to the chosen DSK video layer.

1. First press and hold down the required DSK button on the lower row. The Preset row of input sources will light.
2. While still holding down the DSK button, press to select the required input from the Preset row.
3. The input will flash to confirm it is selected.

This selection will also be confirmed on the HDMI Multi-view, with a T1 or T2 label shown next to the selected input image.

After successfully configuring the down stream keyer settings, press the **ENTER Key** in the **MENU** area of the SE-2850 keyboard. Navigate to the **DSK Settings** option using the down arrow key. The DSK menu options provided here are:

DSK Settings	Titles 1 (DSK1)	Titles + a-CH mode (alpha channel mode)
	Titles 2 (DSK2)	Luma Key mode
		Luma Key Level 0 (black) to 255 (white)

6.3 How to download the CG-200 CG Software

The CG-200 is a piece of CG software that allows users to create subtitles, please visit Datavideo's official website <http://www.datavideo.com/product/CG-200> to download a free copy of the latest CG-200 software.

6.4 HS-2850 and CG Setup

The CG-200 Character Generator software allows the producer to create professional overlays with a Windows laptop or Windows PC from which the CG-200 outputs a computer

generated video stream via an HDMI interface. This software works in perfect pair with the HS-2850 if subtitles are a requirement in your production environment. Please follow the steps outlined below to set up the CG-200 Character Generator software with the HS-2850.

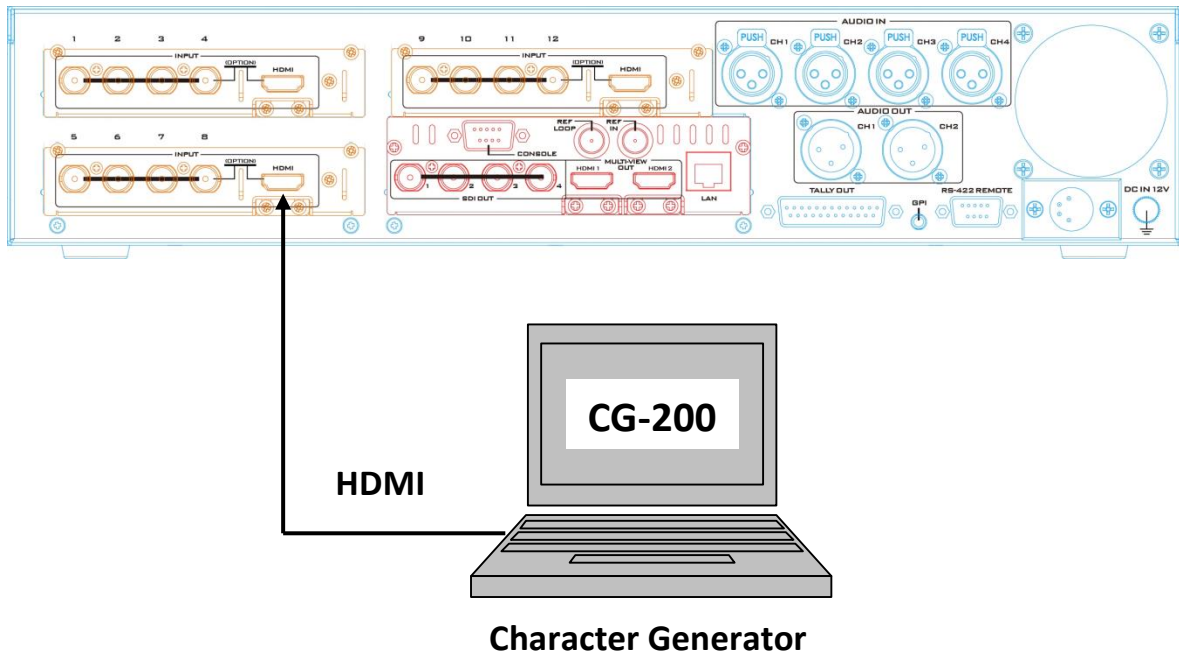

1. Connect your PC to Channel 4 or 8 of the HS-2850 (HDMI port) using an HDMI cable.

**HS-2850
Digital Video Switcher**



2. Open the HS-2850 OSD MENU to set Video Standard.

Video Input Standard and Format	Input 4/8/12	HDMI COLOR MODE	CG-200 MODE
--	--------------	-----------------	-------------

3. Select “**Video Input Standard and Format**” → “Input 4/8/12” → “**HDMI COLOR MODE**” → “**CG-200 Mode**”.
4. Activate Downstream Key on the HS-2850 Control Keyboard. Please see [Section 6.2 Down Stream Keyer](#) for details.
5. Double click the CG-200 installation file icon  to start installing the CG-200 Character Generator software on the PC.
6. Follow the installation wizard to install the CG software step by step and after the installation is complete, double click the program icon  to open the CG software.



7. On the CG-200 User Interface, select Settings → Preference to open the Preference window on which you can choose the appropriate Video Mode (the video mode must be consistent with the HS-2850).

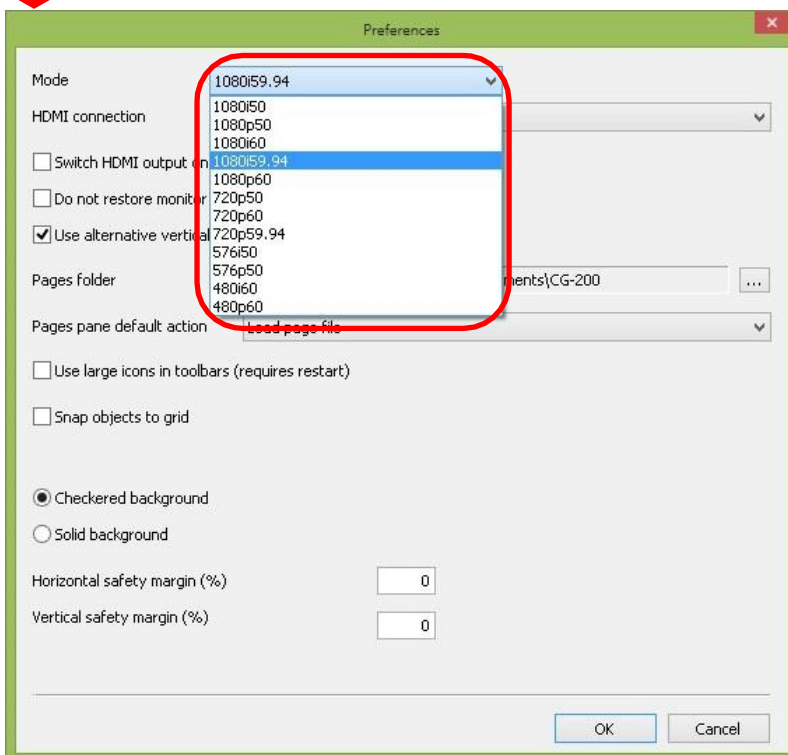
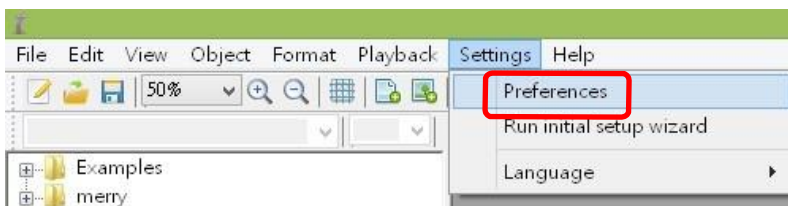

8. Select a Demo file.

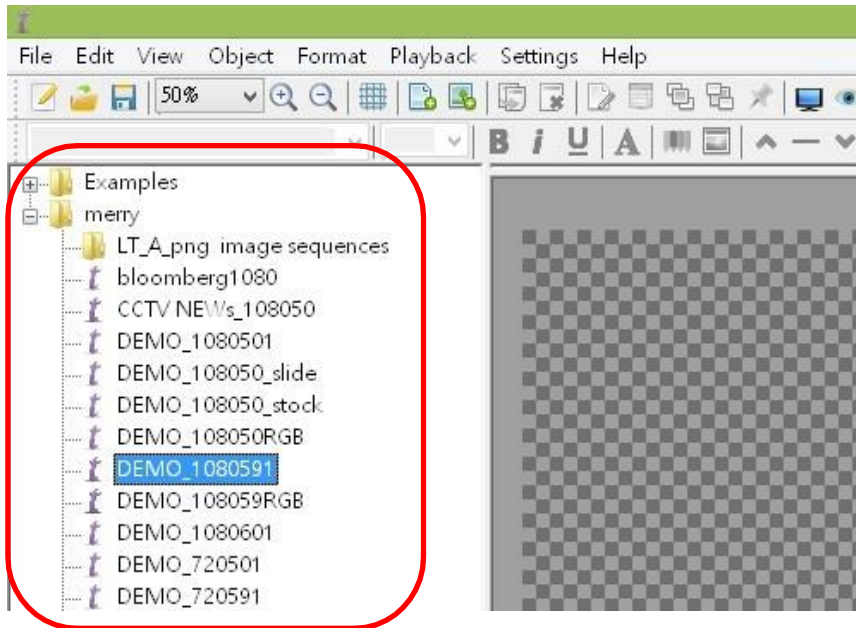

9. Enable HDMI Output.

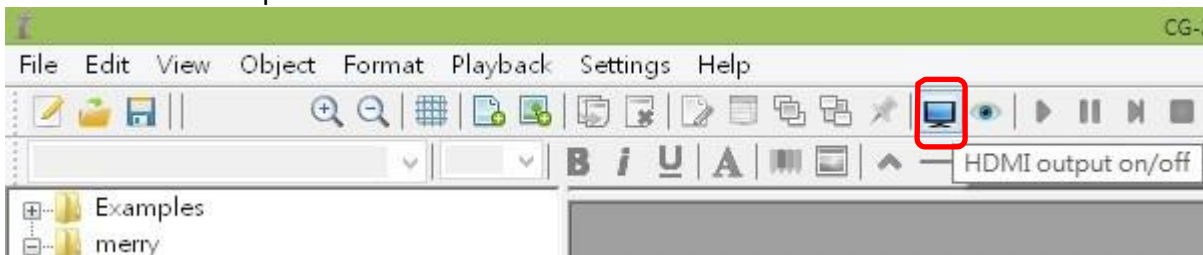

10. Click Play all icon to start playing and streaming your CG contents.

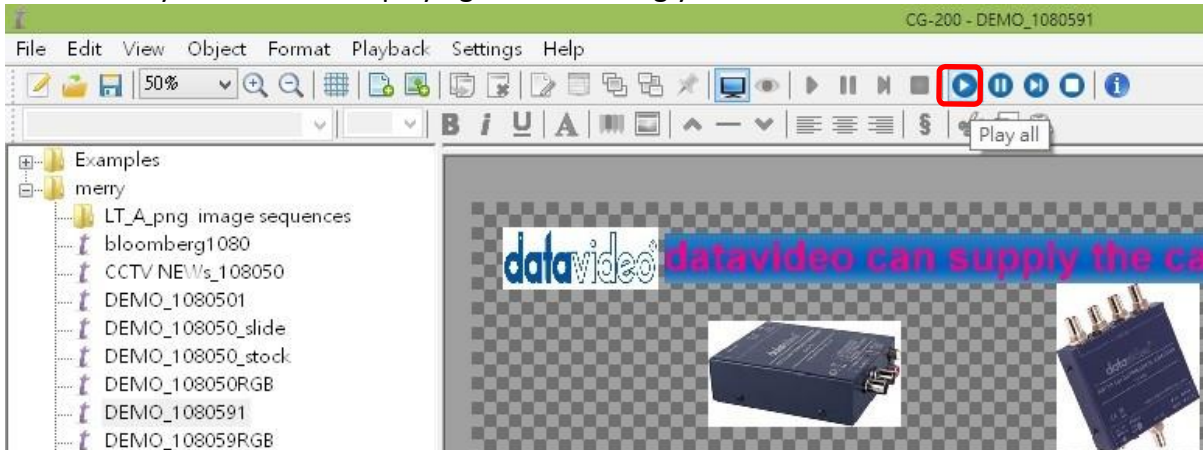

Chapter 7 Appendices

Appendix 1 Upgrading HS-2850 to 12 Channels

- Remove block panel and screws



G0911D300413 Nyloc Machine Screw / ISO Round Head $\phi 3.0 \times 4\text{m/m}$ Nickel-Plated*2
G09220639022 VIDIN Block Panel SECC 1.0 VP-639 Painted Dark Blue Fine Weave 2-Plate Molding*1

- Insert the VIDIN board module



G13307641201 VP-764 SE-2850 VIDIN Board Module (Dark Blue Fine Weave)*1

- Lock the VIDIN board module in place with screws.



G0911D300413 Nyloc Machine Screw / ISO Round Head $\phi 3.0 \times 4\text{m/m}$ Nickel-Plated*2

Appendix 2 Tally Outputs

The HS-2850 has a D-sub 25 pin female tally output port. These connections provide bi-colour tally information to a number of other Datavideo products, such as the ITC-100 eight channel talkback system and the TLM range of LCD Monitors.

These ports are open collector ports and as such do not provide power to tally light circuits.

Dielectric strength: Max. DC 24V

Current: Max. 50mA

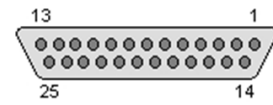

(D-sub 25-Pin Female)

The pin outputs are defined as follows:

Pin No.	Signal name	Input/Output	Signal Description
1	Program 1	Open collector output	Tally output of input video Program 1
2	Program 2	Open collector output	Tally output of input video Program 2
3	Program 3	Open collector output	Tally output of input video Program 3
4	Program 4	Open collector output	Tally output of input video Program 4
5	Program 5	Open collector output	Tally output of input video Program 5
6	Program 6	Open collector output	Tally output of input video Program 6
7	Program 7	Open collector output	Tally output of input video Program 7
8	Program 8	Open collector output	Tally output of input video Program 8
9	Program 9	Open collector output	Tally output of input video Program 9
10	Program 10	Open collector output	Tally output of input video Program 10
11	Program 11	Open collector output	Tally output of input video Program 11
12	Program 12	Open collector output	Tally output of input video Program 12
13	GND	Ground	Ground
14	Preset 1	Open collector output	Tally output of input video Preset 1
15	Preset 2	Open collector output	Tally output of input video Preset 2
16	Preset 3	Open collector output	Tally output of input video Preset 3
17	Preset 4	Open collector output	Tally output of input video Preset 4
18	Preset 5	Open collector output	Tally output of input video Preset 5
19	Preset 6	Open collector output	Tally output of input video Preset 6
20	Preset 7	Open collector output	Tally output of input video Preset 7
21	Preset 8	Open collector output	Tally output of input video Preset 8
22	Preset 9	Open collector output	Tally output of input video Preset 9
23	Preset 10	Open collector output	Tally output of input video Preset 10
24	Preset 11	Open collector output	Tally output of input video Preset 11
25	Preset 12	Open collector output	Tally output of input video Preset 12

Example of tally connections

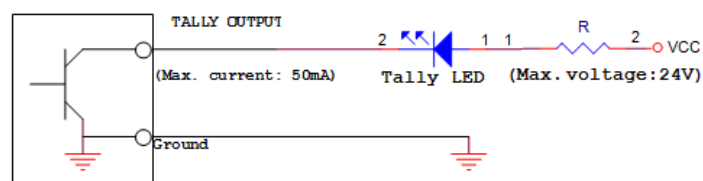

Appendix 3 GPI / GPO Connections

The HS-2850 can control external recorder/playback devices like the HDR-60 and HDR-70 via a simple contact closure GPI / GPO switch.

The GPI interface is a 3.5mm Jack Socket which is situated on the rear panel of the HS-2850. Contact closure between the Outer and Inner contacts on the jack plug will trigger a user selected event. Power is supplied by the HS-2850 and is less than 5V DC.

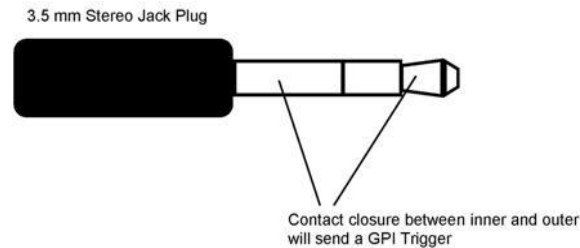

This GPI socket can also be used as a GPO socket to trigger record or playback events with other equipment such as the Datavideo HDR-70 recorder.

SAFETY FIRST The cabling required needs to be designed specifically to connect the HS-2850 to the chosen record or playback device as they are not all the same. The cabling required can be made by yourself or a competent technician. Please speak with your Dealer or local Datavideo office to get further help and advice.

Appendix 4 RS-422 Physical Connection

In addition to the Ethernet port for remote control, you can also connect your PC to this port for controlling the HS-2850 with the SE Remote software. PIN definitions of the RS-422 port of the HS-2850 are described below.

To connect the PC to the HS-2850, you have to make sure the cable and the RS-232 to RS-422 adapter are wired as shown in the diagram below.

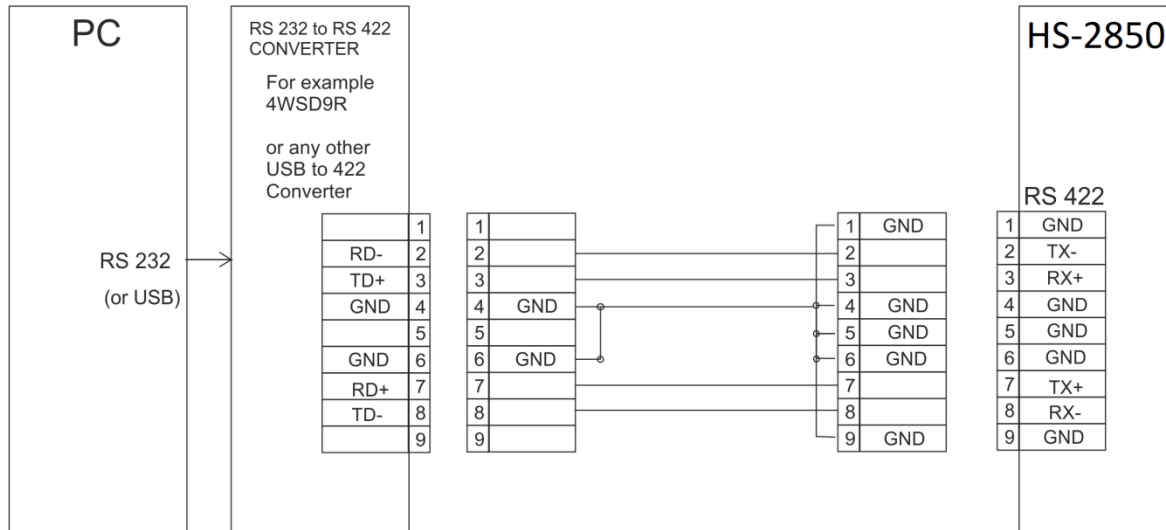

Appendix 5 Firmware Update

Datavideo usually releases new firmware containing new features or reported bug fixes from time to time. Customers can either download the HS-2850 firmware as they wish or contact their local dealer or reseller for assistance.

This section outlines the firmware upgrade process which should take ***approximately 1 hour 20 minutes to complete***.

The existing HS-2850 settings should persist through the *firmware upgrade process, which should not be interrupted once started* as this could result in a non-responsive unit.

Successful firmware upgrade on HS-2850 requires:

- The latest firmware update file for the HS-2850 (This can be obtained from your local Datavideo office or dealer).
- The HS-2850 power adapter.
- The SEConfig software.
- A Windows 7 computer with an Ethernet port.
- An Ethernet cable.

Keyboard Firmware Update

1. Switch off or shut down the HS-2850 and Computer in the normal way.
2. Connect the Ethernet cable between the HS-2850 rear panel and the Windows 7 Computer.
3. Turn on the Windows 7 Computer.
4. Unzip the firmware update folder to the Computer Desktop so the file within it is easy to locate.
5. Double click the firmware update icon to launch the Flash Update Utility.



6. Confirm the supported devices list says ***SE-2850*** then click ***NEXT***.

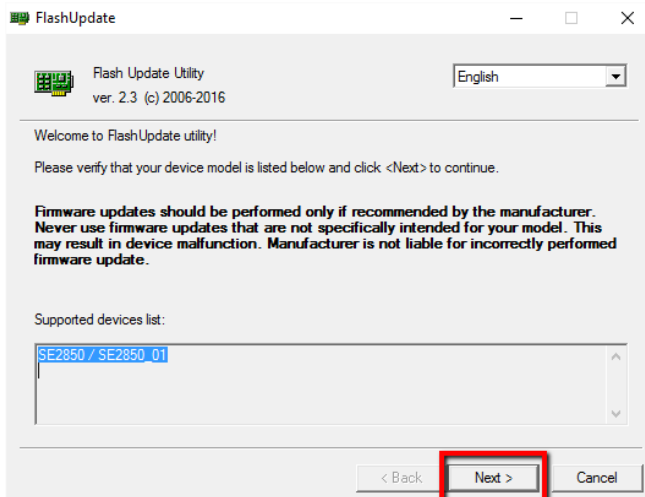

Updating the SE-2850 firmware:

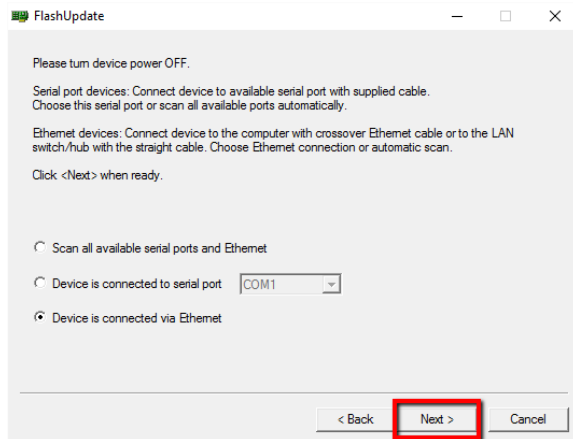

7. The following window will be displayed. Select **Device is connected via Ethernet** then click **NEXT**.

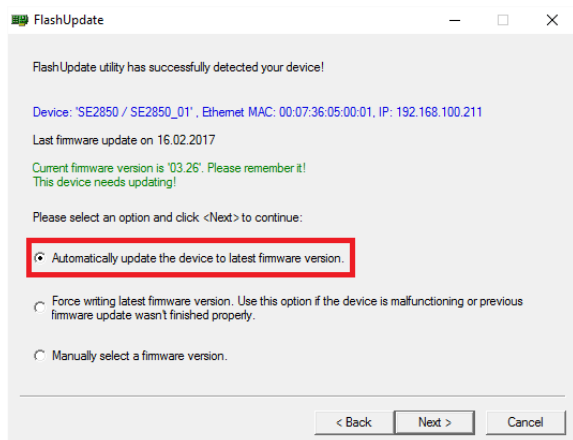

8. **POWER ON** the **SE-2850** and as soon as it is discovered by the Computer, select **"Automatically update the device to latest firmware version"** then click **NEXT**.

9. Click the **Yes button** to confirm you wish to perform the firmware update when you see the prompt window "Do you really want to perform firmware update?".
10. The update process will begin and two progress bars will be shown. The lower bar, Total Progress, will take around 15 minutes to complete.
11. Once this process is complete **close the application** and **power cycle the SE-2850**.

The firmware is now updated, but please continue with the following steps in order to complete the switcher's update process.

12. **Install the SEConfig software on to the Computer**. When the SE-2850 has restarted, double click the **SEConfig** dv icon to launch the second part of the update process.



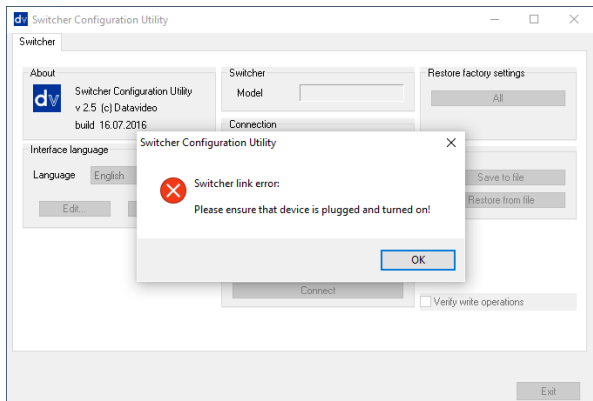

- If you immediately get an error window, do not worry, click **OK**. This simply means that the **PC CTRL** button in the menu area of the SE-2850 control keyboard has not been enabled.

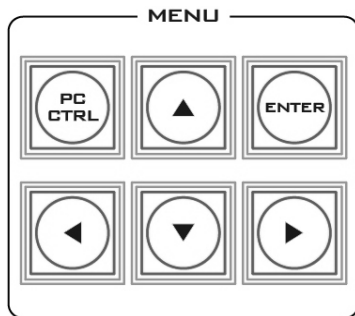

- Press **PC Control** button so it is **ON** in the **MENU area** of the SE-2850 keyboard.

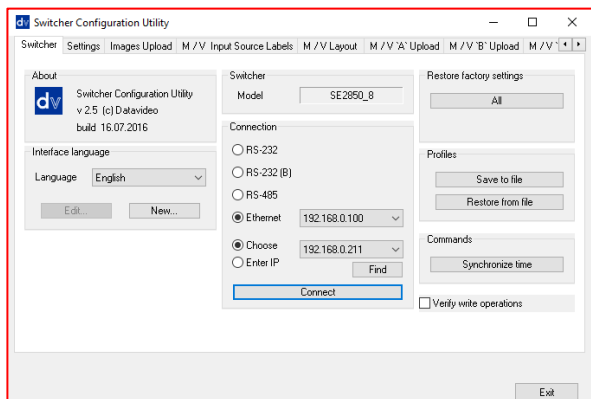

- Select **Ethernet** to display the Computer's IP Address. Click the **Find button** to find and display the SE-2850 Switcher's IP Address in the drop down list. The first three numbers in both IP addresses should match. See below example.

- Click **Connect** and then click **Restore Factory Settings** in the top right hand corner. The process will take approximately 45 minutes to complete.

- The next step will be to re-calibrate the SE-2850 T-Bar to get it working correctly.

T-Bar Re-Calibration

After a firmware update of the switcher it will be necessary to re-calibrate the T-Bar to get it working correctly.

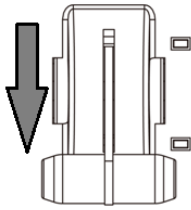

1. Move the **T-Bar** to its **lowest position**.

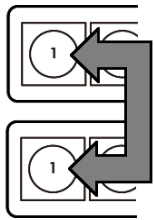

2. **Power OFF** the HS-2850 switcher.

3. Press and **hold down button 1** on both the **Program and Preset** rows of the switcher's keyboard.

4. **Power ON** the HS-2850 switcher while **still holding down the buttons** in step 3.

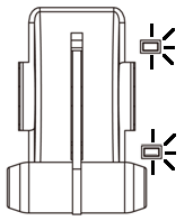

5. The switcher will start but the keyboard lights will remain dead except for the T-Bar progress LEDs. When these **LEDs flash ON and OFF** release the buttons from step 3.

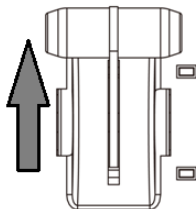

6. Move the **T-Bar to almost its top position (2-3mm away)** and then press the **CUT button**.

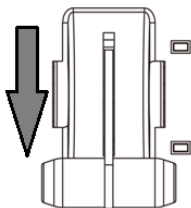

7. Move the **T-Bar back to almost its lowest position (2-3mm away)** and then press the **AUTO TAKE button**.



8. To exit the calibration procedure, press the **CLOCK button**.

9. Ensure the **TIMER button** is **OFF**.

10. Test the T-Bar. If necessary change the **T-Bar Mode** in the **OSD MENU** options.

Monitor Firmware Update

Requirements

- The latest firmware update for the HS-2850 Monitor.
This firmware file can be obtained from your local Datavideo office or dealer.
- USB 2.0 pen drive 128MB or larger with a USB A connector.

How to update the firmware

1. Unzip / extract the supplied zipped archive or rar folder.
2. Delete the contents of the USB 2.0 pen drive so it is empty.
3. Transfer / copy the unzipped / extracted file to the USB 2.0 pen drive; make sure the file name is renamed to MSTFLASH.bin.
4. Plug the USB 2.0 pen drive into the USB 2.0 port labelled MONITOR F/W UPGRADE on the front of the monitor button panel.
5. Reboot **HS-2850** and the update will be automatically in progress.
6. The **HS-2850 Monitor** will reboot itself at the end of the process.

Appendix 6 Frequently-Asked Questions

This section describes problems that you may encounter while using HS-2850. If you have any questions, please refer to related sections and follow all suggested solutions. If problem still exists, please contact your distributor or the service center.

No.	Problems	Solutions
1.	Corrupted images are seen in small windows of the HS-2850 Multiview display.	In the HS-2850, each input source must be associated with only one button. If you associate one source to more than one button, you will then see corrupted images in small windows of the HS-2850 Multiview display. To avoid this please make sure your XPT setting is configured to the one input to one button configuration.
2.	I have enabled the TIMER feature on the selected PGM channel but the countdown timer isn't counting down.	After the TIMER button is enabled on the selected PGM channel, the countdown timer will start on the PGM display as soon as the user switches to the selected PGM channel.
3.	Audio and video are not synced.	In this case, the Video XPT feature might have been activated and if Audio is set to FIX, the Audio XPT must also be enabled to avoid out-of-sync audio and video.
4.	I am seeing jitters in MV audio level indicator.	Check the audio input as this could be due an absence of the audio input.
5.	I hear noise on input channels 5 to 8 after I have changed the resolution.	This can occur as a result of frame rate change (for example 1080i50 → 1080i59). To correct this issue, please factory reset your machine.
6.	Brightness of keys is too bright or too dark.	Please press the Enter key on the MENU area of the keyboard. After that, the OSD menu will show on the screen. Please select the Brightness option in the OSD menu. The key brightness can be defined by the user from level 1 to level 4. 1 equals to high brightness/4 equals to high brightness. For details, please refer to Keys Brightness in the chapter 2.2.7 OSD MENU Options.

Appendix 7 Dimensions & Weight

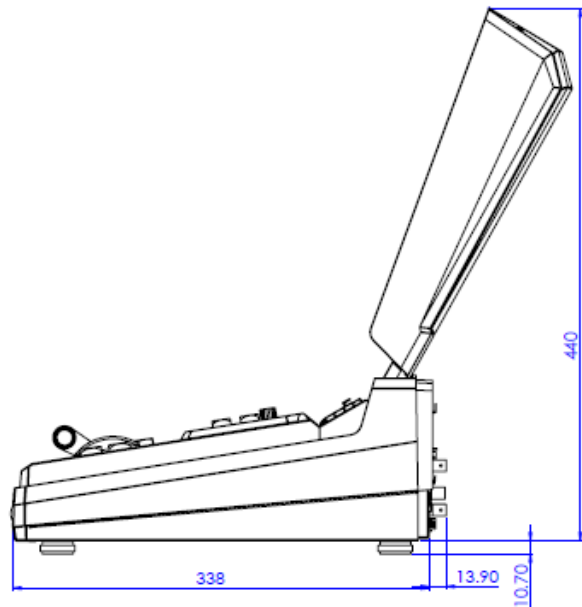
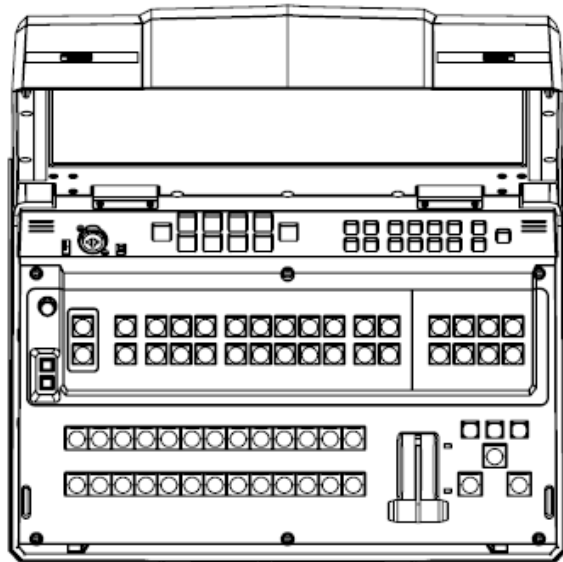
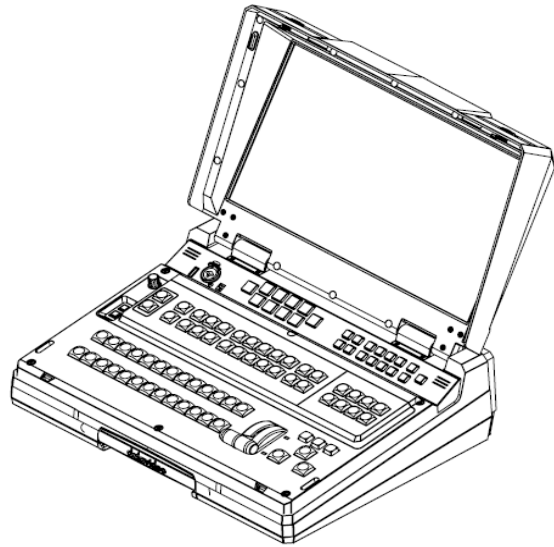
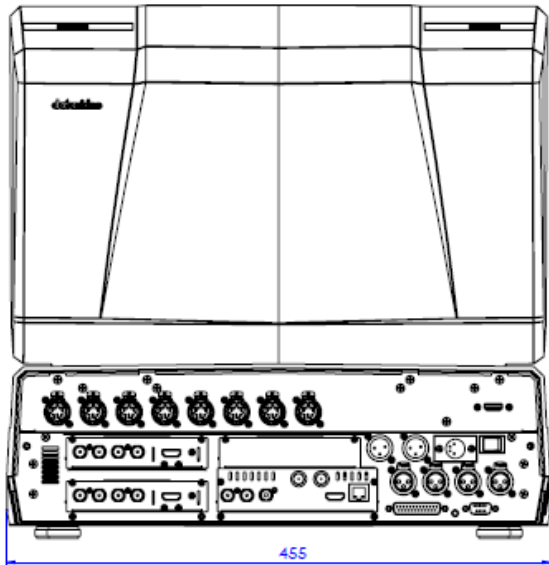

All measurements in millimeters (mm)

Weight: 18.7 Lbs (8.5 Kg)

Appendix 8 Specifications

Switcher System	
Connections	
Total Video Inputs	Total 12 CH inputs 12 HD/SD SDI and 3 HDMI selectable
Total Outputs	3 HD/SD SDI and 1 HDMI
Monitor Input for External device	1 HDMI
Analog Audio Input	4Ch Balanced XLR
Analog Audio Output	2Ch Balanced XLR
Ref Input / Output	1xBNC Ref in / 1xBNC Ref out (loop-through)
Internal Frame Synchronizers	12 All Inputs
PGM Out	SDI
Multi view Out	In SD/HD mode ; MV output by HDMI is 1920x1080P resolution
Output can select any of input source	<ul style="list-style-type: none"> • Program • Preview • Program without logo overlay • Program without logo overlay and without subtitles. • One of the input signals (AUX)
Audio Indicator on Multi view	Each Video input embedded Audio (2 Ch) + Preview (2 Ch)+ Program (4 Ch)
Tally Out	D-Sub 25 pin
GPI	Two mode: Level /Pulse trigger selectable
Ethernet (RJ45)	<ul style="list-style-type: none"> • F/W Upgrade • Upload Still image • Logo insert • Remote control
D-Sub 9 pin connector	RS-422 Remote Control
Power Input	12V DC
Standards	
Format Support	Input: HD : 1080p 25/29.97/30/50/59.94/60Hz 1080i 50/59.94/60Hz 720p 50/59.94/60Hz SD: 576i 50Hz, 480i 59.94Hz Output: 1080i 50/59.94/60Hz
Video Sampling	4:2:2 10bit
Color Precision	4:2:2 10bit
Color Space	4:2:2 YUV
Aspect Converter	Output SD 16:9 or 4:3
Digital Audio Resolution	24 bit
Extras	
Downstream Keyers	2
Linear/Luma Keyers	2

Pattern Generators	Color Bar
Effect	Transition, Split, WIPE, MIX, FTB, CUT
Picture in Picture	2, Shape, Border
Logo insertion	2
TC-200 Build In	Yes
Monitor System	
LCD Display	17.3" TFT LCD
Resolution	RGB 1600 x 900 pixel
Aspect Ratio	4:3 and 16:9 selectable
LED Life time	15,000 hrs. (approx.)
Brightness (Luminance)	220 cd/m ²
Contrast Ratio	650:1
View Angle	Top : 20 deg / Bottom : 45 deg Left : 45 deg / Right : 45 deg
Video System	NTSC / PAL auto recognition
Color Adjustment	Brightness, Contrast, Color Saturation
Intercom System	
Connections	
MIC / Headset	3.5mm Stereo Jack Socket for combination Headphone / Microphone Headset Impedance 8~600 ohms 100mW(min)
Headphone	¼" (6.3mm) Stereo Headphone Socket Headset Impedance 8~600 ohms 100mW(min)
Microphone	3 Pin XLR / ¼" (6.3mm) Jack Microphone Socket Switchable Condenser / Dynamic Input. Microphone Sensitivity Level : -67dB
Speaker Volume Control	Control Knob
Communication interface	8 channels 5 pin XLR
Frequency Response	550-3.6KHz, < +/-3dB
THD	< 3%
S/N	> 50dB
Built-in Speaker	70mm x 30mm 32 Ohm 3 Watts
ITC-100SL Specification	
Input	5 Pin XLR Connector
MIC / Headset Socket	3.5mm Stereo Jack Socket for combination Headphone / Microphone Headset Impedance 8~600 ohms 100mW(min) Microphone Level -67Db or 2.5mm Stereo Jack Socket, for Motorola Mobile Phone type headset / microphone
Tally Out Socket	3.5mm Jack Socket to connect to TD-2 Tally Indicator
Tally LED	Bi-Colour LED – RED indicates LIVE / GREEN Indicates CUED
Power LED	Illuminates to indicate that power is being received

Service & Support

It is our goal to make owning and using Datavideo products a satisfying experience. Our support staff is available to assist you to set up and operate your system. Contact your local office for specific support requests. Plus, please visit www.datavideo.com to access our FAQ section.

China Shanghai
Datavideo Technologies China Co
601, Building 10, No. 1228,
Rd. Jiangchang,
Jingan District, Shanghai
Tel: +86 21-5603 6599
Fax: +86 21-5603 6770
E-mail: service@datavideo.cn

China Beijing
Datavideo Technologies China Co
No. 812, Building B, Wankai Center,
No. 316, Wan Feng Road, Fengtai District,
Beijing, China
Tel: +86 10-8586 9034
Fax: +86 10-8586 9074
E-mail: service@datavideo.cn

China Chengdu
Datavideo Technologies China Co
B-823, Meinian square, No. 1388,
Middle of Tianfu Avenue, Gaoxin District,
Chengdu, Sichuan
Tel: +86 28-8613 7786
Fax: +86 28-8513 6486
E-mail: service@datavideo.cn

China Fuzhou
Datavideo Technologies China Co
A1-2318-19 Room, No. 8, Aojiang Road,
Taijiang District, Fuzhou, Fujian, China
Tel: 0591-83211756 · 0591-83210187
Fax: 0591-83211262
E-mail: service@datavideo.cn

China Jinan
Datavideo Technologies China Co
902, No. 1 business building,
Xiangtai Square, No. 129,
Yingxiongshan Road, Shizhong District,
Jinan City, Shandong Province, China
Tel: +86 531-8607 8813
E-mail: service@datavideo.cn

Hong Kong
Datavideo Hong Kong Ltd
G/F., 26 Cross Lane
Wanchai, Hong Kong
Tel: +852-2833-1981
Fax: +852-2833-9916
E-mail: info@datavideo.com.hk

India Noida
Datavideo India Noida
A-132, Sec-63, Noida-201307,
India
Tel: +91-0120-2427337
Fax: +91-0120-2427338
E-mail: sales@datavideo.in

India Kochi
Datavideo India Kochi
2nd Floor- North Wing, Govardhan Building,
Opp. NCC Group Headquarters, Chittoor Road,
Cochin- 682035
Tel: +91 4844-025336
Fax: +91 4844-047696
E-mail: sales@datavideo.in

Netherlands
Datavideo Technologies Europe BV
Floridadreef 106
3565 AM Utrecht,
The Netherlands
Tel: +31-30-261-96-56
Fax: +31-30-261-96-57
E-mail: info@datavideo.nl

Singapore
Datavideo Visual Technology(S) Pte Ltd
No. 178 Paya Lebar Road #06-07
Singapore 409030
Tel: +65-6749 6866
Fax: +65-6749 3266
E-mail: info@datavideovirtualset.com

Singapore
Datavideo Technologies (S) PTE Ltd
No. 178 Paya Lebar Road #06-03
Singapore 409030
Tel: +65-6749 6866
Fax: +65-6749 3266
E-mail: sales@datavideo.sg

Taiwan
Datavideo Technologies Co. Ltd
10F. No. 176, Jian 1st Rd., Chung Ho
District, New Taipei City 235, Taiwan
Tel: +886-2-8227-2888
Fax: +886-2-8227-2777
E-mail: service@datavideo.com.tw

United States
Datavideo Corporation
7048 Elmer Avenue.
Whittier, CA 90602,
U.S.A.
Tel: +1-562-696 2324
Fax: +1-562-698 6930
E-mail: sales@datavideo.com

United Kingdom
Datavideo UK Limited
Brookfield House, Brookfield Industrial
Estate, Peakdale Road, Glossop,
Derbyshire, SK13 6LQ
Tel: +44-1457 851 000
Fax: +44-1457 850 964
E-mail: sales@datavideo.co.uk

France
Datavideo France s.a.r.l.
Cit  Descartes 1, rue Albert Einstein
Champs sur Marne 774477 –
Marne la Vall e cedex 2
Tel: +33-1-60370246
Fax: +33-1-60376732
E-mail: info@datavideo.fr



Please visit our website for latest manual update.

www.datavideo.com/product/HS-2850

datavideo
www.datavideo.com